

IMfinity® Liquid cooled motors - LC series

3-phase induction motors
IE3 Premium efficiency
Variable and fixed speed
Frame size 315 to 500
150 to 1500 kW

LEROY-SOMER™

Nidec
All for dreams

The LC induction motors in this catalog are designed to achieve very high efficiency levels and operate at variable speed.

This catalog contains technical information about motors in the IE3 efficiency class (Premium efficiency) which can be used on an A.C. supply and also on a drive.

On request, Leroy-Somer is able to offer IE4 motor solutions.

All the motors in this catalog can be used at variable speed depending on the specified conditions.



All 2, 4 and 6-pole motors, rated 0.75 to 375 kW, offered for sale on the European Union market must be efficiency class IE3 or IE2 and used with a variable speed drive:

- from 01/01/2015 for 7.5 to 375 kW ratings**
- from 01/01/2017 for 0.75 to 375 kW ratings**

In addition, to be eligible for efficiency class IE3, the water inlet temperature for water-cooled motors must be between 0°C and 32°C.

Contents

GENERAL

Introduction	4
Quality Commitment	5
Directive and Standards Relating to Motor Efficiency.....	6
Standards and Approvals.....	7
Regulations in the Main Countries	10

ENVIRONMENT

Definition of “Index of Protection”	11
Environmental Limitations.....	12
Impregnation and Enhanced Protection.....	13
Heating	14
External Finish	15
Interference Suppression and Protection of People	16

CONSTRUCTION

Bearings and Bearing Life.....	17
Lubrication and Maintenance of Bearings	18

OPERATION

Duty Cycle - Definitions.....	19
Supply Voltage.....	22
Insulation Class - Temperature Rise and Thermal Reserve	24
Starting Times and Starting Current.....	25
Power - Torque - Efficiency - Power Factor (Cos ϕ).....	26
Noise Level.....	29
Weighted Sound Level [dB(A)].....	30
Vibrations.....	31
Performance.....	33
Starting Methods for Induction Motors	34
Braking	38
Use with a Variable Speed Drive	40
Operation as an Asynchronous Generator	47
Special Environments	49

TECHNICAL CHARACTERISTICS

Designation.....	50
Identification	51
Description of an LC Motor basic conception	53
Cooling	54
Standard Equipment.....	56
Optional Features	57
Handling	58

ELECTRICAL CHARACTERISTICS

IE3 Mains Supply	59
IE3 Variable Speed Drive Supply	61
Terminal Block Connection	63

MECHANICAL CHARACTERISTICS

Mounting Arrangements.....	64
Terminal Box Connection	65
Dimensions of Shaft Extensions	69
Dimensions of Foot Mounted IM 1001 (IM B3)	70
Dimensions of Foot and Flange Mounted IM 2001 (IM B35).....	71
Dimensions of Flange Mounted IM 3001 (IM B5) IM 3011 (IMV1)	72
Dimensions - Water Connecting Flange.....	73
Bearings and Lubrication	74
Axial Loads	75
Radial Loads.....	77

APPENDIX

Configurator.....	91
-------------------	----

General Introduction

In this catalog, Leroy-Somer describes high-efficiency liquid-cooled induction motors. These motors have been designed to incorporate the latest European standards, and can satisfy most of industry's demands. They are par excellence the leading products on the Leroy-Somer liquid-cooled IMfinity® platform.



Liquid-cooled motors are particularly suitable for and are used in applications requiring a low noise level, high output power with IP55 protection, compact dimensions and operation on a drive.

Advantages

- Motor cooled by a water circuit integrated in the housing (IC71W)
- Reduced noise level: the water cooling system means the fan is no longer necessary and ensures a reduced noise level (between 60 and 80 dB (A) in LpA)
- IE3 Premium efficiency across the whole range: 150 to 1500 kW - 2, 4 & 6-pole
- Compact design: weight and dimensions can be as much as 25% less than an air-cooled IP55 motor, and as much as 55% less than an IP55 motor cooled by an air/water exchanger (IC81W)
- Degree of protection higher than IP55 (e.g.: IP56) as an option
- Motor adapted for use at constant torque across the entire speed range from 0 to 50 Hz, without derating. The motor is always cooled, whatever the point of operation.
- Reduced vibration level
- Heat recovery thanks to dissipation of losses by an external water circuit

Application areas

- Marine: main propulsion and bow thruster units, equipment on the bridge of the ship
- Test benches: automotive, aeronautics
- Pumps, compressors, agitators, mixers
- Plastics industries: extrusion and plastic injection machines
- Hydraulic turbines
- Heavy industries: iron and steel, cement, chemical industries



General Quality Assurance

Leroy-Somer's quality management system is based on:

- Tight control of procedures right from the initial sales offering through to delivery to the customer, including the design process, manufacturing start-up and production.
- A total quality policy based on making continuous progress in improving operational procedures, involving all departments in the company in order to give customer satisfaction as regards delivery times, conformity and cost.
- Indicators used to monitor process performance.
- Corrective actions and advancements with tools such as FMECA, QFD, MAVP, MSP/MSQ and Hoshin type improvement workshops on flows, process re-engineering, plus Lean Manufacturing and Lean Office.
- Annual surveys, opinion polls and regular visits to customers in order to ascertain and detect their expectations.

Personnel are trained and take part in the analyses and the actions for continuously improving the procedures.

A special study of the motors in this catalog has been conducted to measure the impact of their life cycle on the environment. This eco-design process has resulted in the creation of a "Product Environmental Profile" (references 4592/4950/4951).

Leroy-Somer has entrusted the certification of its expertise to various international organizations.

Certification is granted by independent professional auditors, and recognizes the high standards of the company's quality assurance procedures. All activities resulting in the final version of the machine have therefore received official ISO 9001:2008 certification from the DNV.

Similarly, our environmental approach has enabled us to obtain ISO 14001:2004 certification.

Products for particular applications or those designed to operate in specific environments are also approved or certified by the following organizations: LCIE, DNV, INERIS, EFECTIS, UL, BSRIA, TUV, GOST, which check their technical performance against the various standards or recommendations.



ISO 9001 : 2008



General

Directive and Standards Relating to Motor Efficiency

There have been a number of changes to the standards and new standards created in recent years. They mainly concern motor efficiency and their scope includes measurement methods and motor classification.

Regulations are gradually being implemented, both nationally and internationally, in many countries in order to promote the use of high-efficiency motors (Europe, USA, Canada, Brazil, Australia, New Zealand, Korea, China, Israel, etc.).

The new generation of Premium efficiency three-phase induction motors responds to changes in the standards as well as the latest demands of system integrators and users.

STANDARD IEC 60034-30-1

(January 2014) defines the principle to be adopted and brings global harmonization to energy efficiency classes for electric motors throughout the world.

Motors concerned

Induction or permanent magnet, single-phase and three-phase single-speed cage motors, on a sinusoidal A.C. supply.

Scope:

- U_n from 50 to 1000 V
- P_n from 0.12 to 1000 kW
- 2, 4, 6 and 8 poles
- Continuous duty at rated power without exceeding the specified insulation class. Generally known as S1 duty.
- 50 and 60 Hz frequency
- On the A.C. supply
- Rated for an ambient temperature between -20°C and $+60^{\circ}\text{C}$
- Rated for altitude up to 4000 m
- Water inlet temperature from 0°C to $+32^{\circ}\text{C}$

Motors not concerned

- Motors with frequency inverter when the motor cannot be tested without it.
- Brake motors when they form an integral part of the motor construction and can neither be removed nor supplied separately in order to be tested.
- Motors which are fully integrated in a machine and cannot be tested separately (such as rotor/stator).

STANDARD FOR MEASURING THE EFFICIENCY OF ELECTRIC MOTORS: IEC 60034-2-1 (September 2007)

Standard IEC 60034-2-1 concerns asynchronous induction motors:

- Single-phase and three-phase with power ratings of 1 kW or less. The preferred method is the D.O.L. method
- Three-phase motors with power ratings above 1 kW. The preferred method is the summation of losses method with the total of additional losses measured.

Comments:

- The standard for efficiency measurement is very similar to the IEEE 112-B method used in North America.
- Since the measurement method is different, this means that for the same motor, the rated value will be different (usually lower) with IEC 60034-2-1 than with IEC 60034-2.

DIRECTIVE 2009/125/EC (21 October 2009)

from the European Parliament established a framework for setting the eco-design requirements to be applied to "energy-using products". These products are grouped in lots. Motors come under lot 11 of the eco-design program, as do pumps, fans and circulating pumps.

DECREE IMPLEMENTING EUROPEAN DIRECTIVE ErP (Energy Related Product) EC/640/2009 - LOT 11 (July 2009) + EU/4/2014 (January 2014)

This is based on standard IEC 60034-30-1 and will define the efficiency classes whose use will be mandatory in the future. It specifies the efficiency levels to be attained for machines sold in the European market and outlines the timetable for their implementation.

Efficiency classes	Efficiency level
IE1	Standard
IE2	High
IE3	Premium
IE4	Super Premium

This standard only defines efficiency classes and their conditions. It is then up to each country to define the efficiency classes and the exact scope of application.

EUROPEAN DIRECTIVE ErP

Motors concerned: 2-, 4- and 6-pole induction motors between 0.75 and 375 kW.

Obligation to place high-efficiency or Premium efficiency motors on the market:

- IE2 class from 16 June 2011
- Class IE3* from 1 January 2015 for power ratings from 7.5 to 375 kW
- Class IE3* from 1 January 2017 for power ratings from 7.5 to 375 kW

The European Commission is currently working to define minimum efficiency values for drives.

* or IE2 motor + drive

Motors not concerned:

- Motors designed to operate when fully submerged in liquid
- Motors which are fully integrated in another product (rotor/stator)
- Motors with duty other than continuous duty
- Motors designed to operate in the following conditions:
 - Altitude > 4000 m
 - Ambient air temperature > 60°C
 - Maximum operating temperature > 400°C
 - Ambient air temperature < -30°C or < 0°C for air-cooled motors
 - **Cooling water temperature at product inlet < 0°C or > 32°C**
 - Safety motors conforming to directive ATEX 2014/34/EU
 - Brake motors
 - Onboard motors

General Standards and Approvals



LIST OF STANDARDS QUOTED IN THIS DOCUMENT

Reference		International Standards
IEC 60034-1	EN 60034-1	Rotating electrical machines: rating and performance.
IEC 60034-2		Rotating electrical machines: methods for determining losses and efficiency from tests (additional losses added as a fixed percentage).
IEC 60034-2-1		Rotating electrical machines: methods for determining losses and efficiency from tests (additional losses added as a measured percentage).
IEC 60034-5	EN 60034-5	Rotating electrical machines: classification of degrees of protection provided by casings of rotating machines.
IEC 60034-6	EN 60034-6	Rotating electrical machines (except traction): methods of cooling
IEC 60034-7	EN 60034-7	Rotating electrical machines (except traction): symbols for mounting positions and assembly layouts
IEC 60034-8		Rotating electrical machines: terminal markings and direction of rotation
IEC 60034-9	EN 60034-9	Rotating electrical machines: noise limits
IEC 60034-12	EN 60034-12	Starting performance of single-speed three-phase cage induction motors for supply voltages up to and including 660 V.
IEC 60034-14	EN 60034-14	Rotating electrical machines: mechanical vibrations of certain machines with a frame size above or equal to 56 mm. Measurement, evaluation and limits of vibration severity
IEC 60034-17		Cage induction motors when fed from converters - Application guide
IEC 60034-30-1		Rotating electrical machines: efficiency classes of single-speed, three-phase cage induction motors (IE code).
IEC 60038		IEC standard voltages.
IEC 60072-1		Dimensions and output powers for rotating electrical machines: designation of casings between 56 and 400 and flanges between 55 and 1080
IEC 60085		Evaluation and thermal classification of electrical insulation
IEC 60721-2-1		Classification of environmental conditions. Temperature and humidity
IEC 60892		Effects of unbalanced voltages on the performance of 3-phase cage induction motors
IEC 61000-2-10/11 and 2-2		Electromagnetic compatibility (EMC): environment.
IEC guide 106		Guide for specifying environmental conditions for equipment performance rating
ISO 281		Bearings - Dynamic load ratings and nominal bearing life
ISO 1680	EN 21680	Acoustics - Test code for the measurement of airborne noise emitted by rotating electrical machines: a method for establishing an expert opinion for free field conditions over a reflective surface.
ISO 8821		Mechanical vibration - Balancing. Shaft and fitment key conventions.
	EN 50102	Degree of protection provided by electrical enclosures against extreme mechanical impacts
ISO 12944-2		Corrosion protection

General Standards and Approvals

MAIN PRODUCT MARKINGS WORLDWIDE

Special markings are in place all over the world. They primarily concern product compliance with safety standards for users in force in countries. Some markings or labels only apply to energy regulations. One country can have two different markings: one for safety and one for energy.





	This marking is mandatory in the European Economic Community market. It means that the product complies with all relevant directives. If the product does not comply with an applicable directive, it cannot be CE-rated and hence cannot bear the CE mark.
	In Canada and the United States : The CSA mark accompanied by the letters C and US mean that the product is certified for the American and Canadian markets, according to the relevant American and Canadian standards. If a product has characteristics arising from more than one product genre (e.g.: electrical equipment including fuel combustion), the mark indicates compliance with all relevant standards.
	This mark only applies to finished products such as complete machines. A motor is only a component and is not therefore affected by this marking.

Note: c CSA us and c UL us mean the same thing but one is awarded by the CSA and the other by UL.

	The c UL us mark, which is optional, indicates compliance with Canadian requirements and those of the United States. UL encourages manufacturers distributing products with the Recognized UL mark for both countries to use this combined mark.
--	---

For Canada, c UR us or c CSA us is a minimum requirement. It is also possible to have both.

Components covered by the UL "Recognized Mark" program are destined for installation in another device, system or end product. They will be installed in the factory, not in the field, and it is possible that their performance capacity will be restricted, limiting their use. When a product or complete system containing UL Recognized components is assessed, the process of assessing the end product can be rationalized.

	Canada: energy efficiency compliance logo (optional).
	USA: energy efficiency compliance logo (optional).
	USA and Canada: EISA commercial compliance logo (optional).
	This marking is mandatory for the Chinese market. It indicates that the product complies with current regulations (user safety). It concerns electric motors rated ≤ 1.1 kW.
	The EAC mark has replaced the GOST mark. It is the equivalent of the CE mark for the European Union market. This new mark covers regulations for Russia, Kazakhstan and Belarus. All products offered for sale in these three countries must bear this mark.

Other marks concern certain applications such as ATEX for example.

General Standards and Approvals

INTERNATIONAL AND NATIONAL STANDARD EQUIVALENTS

International reference standards		National standards				
IEC	Title (summary)	FRANCE	GERMANY	UK	ITALY	SWITZERLAND
60034-1	Ratings and operating characteristics	NFEN 60034-1 NFC 51-120 NFC 51-200	DIN/VDE 0530	BS 4999	CEI 2.3.VI.	SEV ASE 3009
60034-5	Classification of degrees of protection	NFEN 60034-5	DIN/EN 60034-5	BS EN 60034-5	UNEL B 1781	
60034-6	Cooling methods	NFEN 60034-6	DIN/EN 60034-6	BS EN 60034-6		
60034-7	Mounting arrangements and assembly layouts	NFEN 60034-7	DIN/EN 60034-7	BS EN 60034-7		
60034-8	Terminal markings and direction of rotation	NFC 51 118	DIN/VDE 0530 Teil 8	BS 4999-108		
60034-9	Noise limits	NFEN 60034-9	DIN/EN 60034-9	BS EN 60034-9		
60034-12	Starting characteristics for single-speed motors for supply voltages ≤ 660 V	NFEN 60034-12	DIN/EN 60034-12	BS EN 60034-12		SEV ASE 3009-12
60034-14	Mechanical vibrations of machines with frame size ≥ 56 mm	NFEN 60034-14	DIN/EN 60034-14	BS EN 60034-14		
60072-1	Dimensions and output powers for machines of between 56 and 400 frame and flanges of between 55 and 1080.	NFC 51 104 NFC 51 105	DIN 748 (~) DIN 42672 DIN 42673 DIN 42631 DIN 42676 DIN 42677	BS 4999		
60085	Evaluation and thermal classification of electrical insulation.	NFC 26206	DIN/EN 60085	BS 2757		SEV ASE 3584

Note: DIN 748 tolerances do not conform to IEC 60072-1.

General Regulations in the Main Countries

Many countries have already implemented energy regulations concerning electric motors. Others are in the process of preparing them.

Some regulations require that before they can be offered for sale, products must be registered with the local authorities. In these cases, market surveillance is undertaken before the products are put into use, unlike the EU where the member states are responsible for organizing surveillance on their own territory.

The majority of countries requiring registration before products are offered for sale also usually require special product labeling.

For Europe, there is no special label. Only CE marking indicates that the product complies with all the relevant directives.

As regulations are constantly changing and vary from country to country, it is advisable to check for updates on a regular basis.

For more details of the efficiency classes applicable for each power rating and number of motor poles according to the timetable, please contact your local Leroy-Somer sales office.

Environment

Definition of “Index of Protection” (IP)

INGRESS PROTECTION OF ELECTRICAL EQUIPMENT ENCLOSURES

In accordance with IEC 60034-5 - EN 60034-5 (IP) - IEC 62262 (IK)

IP	Tests	Definition	IP	Tests	Definition	IK	Tests	Definition
0		No protection	0		No protection	00		No protection
1	 Ø 50 mm Protected against solid objects larger than 50 mm (e.g. accidental contact with the hand)		1	 Protected against water drops falling vertically (condensation)		01	 150 g 10 cm Impact energy: 0.15 J	
2	 Ø 12 mm Protected against solid objects larger than 12 mm (e.g. a finger)		2	 15° Protected against water drops falling at up to 15° from the vertical		02	 200 g 10 cm Impact energy: 0.20 J	
3	 Ø 2.5 mm Protected against solid objects larger than 2.5 mm (e.g. tools, wires)		3	 60° Protected against rain falling at up to 60° from the vertical		03	 250 g 15 cm Impact energy: 0.37 J	
4	 Ø 1 mm Protected against solid objects larger than 1 mm (e.g. thin tools, small wires)		4	 Protected against projected water from all directions		04	 250 g 20 cm Impact energy: 0.50 J	
5	 Protected against dust (no deposits of harmful material)		5	 Protected against jets of water from all directions from a hose		05	 350 g 20 cm Impact energy: 0.70 J	
6	 Protected against any dust penetration		6	 Protected against projected water comparable to big waves		06	 250 g 40 cm Impact energy: 1 J	
			7	 Protected against the effects of immersion between 0.15 and 1 m		07	 0.5 kg 40 cm Impact energy: 2 J	
			8	 Protected against prolonged effects of immersion under pressure		08	 1.25 kg 40 cm Impact energy: 5 J	
						09	 2.5 kg 40 cm Impact energy: 10 J	
						10	 5 kg 40 cm Impact energy: 20 J	

Example:

Example of a liquid-cooled IP 55 machine

IP : Protection index

5. : Machine protected against dust and accidental contact.

Test result: no dust enters in harmful quantities, no risk of direct contact with rotating parts. The test will last for 2 hours.

.5 : Machine protected against jets of water from all directions from hoses at 3 m distance with a flow rate of 12.5 l/min at 0.3 bar.

The test will last for 3 minutes.

Test result: no damage from water projected onto the machine.

Environment Environmental Limitations

NORMAL OPERATING CONDITIONS

According to IEC 60034-1, motors can operate in the following normal conditions:

- ambient temperature between -16°C and +40°C
- altitude less than 1000 m
- atmospheric pressure: 1050 hPa (mbar) = (750 mm Hg)

The ambient temperature must not be less than +5°C for water-cooled motors. If this is the case, antifreeze must be added to the water for temperatures less than +5°C.

Special operating conditions can be discussed on request.

NORMAL STORAGE CONDITIONS

The storage area must be closed and covered, protected against mold, vapors and other harsh, corrosive (chemical) substances. The storage area ambient temperature must be between +5°C and +60°C, at a relative humidity of less than 50%, and must not be subject to sudden temperature variations. Storage outdoors is not recommended.

For restarting, see commissioning manual.

In temperate climates, relative humidity is generally between 50 and 70%. For the relationship between relative humidity and motor impregnation, especially where humidity and temperature are high, see table on next page.

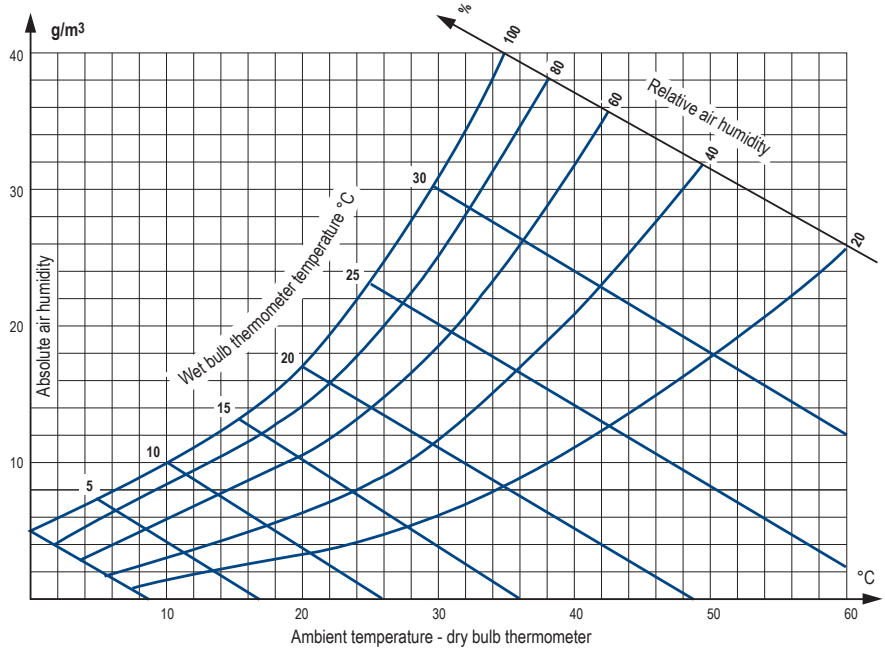

RELATIVE AND ABSOLUTE HUMIDITY

Measuring the humidity:

Humidity is usually measured by the “wet and dry bulb thermometer” method. Absolute humidity, calculated from the readings taken on the two thermometers, can be determined using the above chart. The chart also provides relative humidity figures.

To determine the humidity correctly, a good air flow is required for stable readings, and accurate readings must be taken on the thermometers.

DRAIN HOLES

Holes are provided at the lowest points of the housing, depending on the operating position (IM, etc.) to drain off any moisture that may have accumulated inside during cooling of the machine. As standard, the holes are sealed with metal plugs.

Under certain special conditions, it is advisable to leave the drain holes permanently open (operating in environments with high levels of condensation). Opening the holes periodically should be part of the regular maintenance procedures.

Environment Impregnation and Enhanced Protection

NORMAL ATMOSPHERIC PRESSURE (750 MM HG)

The selection table below can be used to find the method of manufacture best suited to particular environments in which temperature and relative humidity show large degrees of variation (see relative and absolute humidity calculation method, on preceding page).

The winding protection is generally described by the term "tropicalization".

For high humidity environments, we recommend that the windings are pre-heated (see next page).

Ambient temperature \ Relative humidity		Relative humidity	
		RH ≤ 95%	RH ≥ 95%*
T° < -16°C		Please consult LS	Please consult LS
-16°C to +50°C		Standard	Tropicalization
T° > +50°C		Please consult LS	Please consult LS
Influence on construction		Stainless steel screws as standard	Tropicalization: rotor and stator protection

* Atmosphere without high levels of condensation

Tropicalization refers to protection of the motor's electrical parts (rotor, stator and coil end turns). It is available as an option for all motor versions.

Environment Heating

SPACE HEATERS

Severe climatic conditions may require the use of space heaters (fitted to the motor windings) which serve to maintain the average temperature of the motor, provide trouble-free starting, and eliminate problems caused by condensation (loss of insulation).

The heater supply wires are brought out to a terminal block in the motor's auxiliary terminal box.

The heaters must be switched off while the motor is running.

Table of space heater power ratings by type of LC motor

Motor type	Power (W)
LC 315 LA/LB	150
LC 315 LKA/LKB/LKC	200
LC 355 LA/LB/LC	
LC 355 LKA/LKB/LKC	300
LC 400 LA	
LC 400 LKA	
LC 450 LA/LB	
LC 500 M/L	400

The space heaters use 200/240 V, single-phase, 50 or 60 Hz.

A.C. INJECTION HEATING

A single-phase A.C. voltage (from 10 to 15% of rated voltage), can be used between 2 phases placed in series.

This method can be used on the whole motor range.

This function can be performed by a frequency inverter.

Environment External Finish

Surface protection is defined in standard ISO 12944. This standard defines the expected life of a paint system until the first major application of maintenance paint. Durability is not guaranteed.

Standard EN ISO 12944 is divided into 8 parts. Part 2 discusses the classification of environments.

Leroy-Somer motors are protected with a range of surface finishes.

Surfaces receive appropriate special treatments, as shown below.

Leroy-Somer standard paint color reference:

RAL 6000

PREPARATION OF SURFACES

Surface	Parts	Surface treatment
Cast iron	End shields	Shot blasting + Primer
Steel	Accessories	Phosphate treatment + Primer
	Terminal boxes - Fan covers - End shields	Electrostatic painting or Epoxy powder

CLASSIFICATION OF ENVIRONMENTS

Leroy-Somer paint systems according to category.

Atmospheric corrosivity categories	Corrosivity category* a/c to ISO 12944-2	Durability class	ISO 6270	ISO 9227	Form LS	Leroy-Somer system equivalent
			Water condensation Number of hours	Neutral saline mist Number of hours		
MEDIUM	C3	Medium	120	240	101b	IIa
		High	240	480	132b	IIb standard for LC motors
HIGH	C4	Limited	120	240	-	-
		Medium	240	480	102c	IIIa
		High	480	720	106b	IIIb**
VERY HIGH (Industry)	C5-I	Limited	240	480	165	IVb**
		Medium	480	720	140b	Ve**
		High	720	1440	-	-
VERY HIGH (Marine)	C5-M	Limited	240	480	-	-
		Medium	480	720	-	-
		High	720	1440	161b	161b**

* Values given for information only since the substrates vary in nature whereas the standard only takes account of steel substrates.

** Assessment of degree of rusting in accordance with standard ISO 4628 (rust over 1 to 0.5% of the surface).

CORROBLOC FINISH AVAILABLE AS AN OPTION

Component	Materials	Comments
Stator-Rotor		Dielectric and anti-corrosion protection
Nameplates	Stainless steel	Nameplate: indelible marking
Screws	Stainless steel	
Cable glands	Brass	
External finish		System IIIa

Note: On LC motors, the screws and nameplates are routinely made of stainless steel.

Environment

Interference Suppression and Protection of People

AIRBORNE INTERFERENCE

EMISSION

For standard motors, the housing acts as an electromagnetic screen, reducing electromagnetic emissions measured at 0.25 meters from the motor to approximately 5 gauss (5×10^{-4} T).

However, electromagnetic emissions can be noticeably reduced by a specially-constructed stainless steel shaft.

IMMUNITY

The construction of the motor housings isolates external electromagnetic sources to the extent that any field penetrating the casing and magnetic circuit will be too weak to interfere with the operation of the motor.

POWER SUPPLY INTERFERENCE

The use of electronic systems for starting, variable speed control or power supply can create harmonics on the supply lines that may interfere with operation of the machines. These phenomena are taken into account in determining the machine dimensions, which act as quenching chokes in this respect.

The IEC 61000 standard, currently in preparation, will define permissible rejection and immunity rates: only then will machines for general distribution (especially single-phase motors and commutator motors) have to be fitted with suppression systems.

Three-phase squirrel cage machines do not in themselves produce interference of this type. A.C. supply connection equipment (contactors) may, however, need interference protection.

APPLICATION OF DIRECTIVE 2004/108/EC CONCERNING ELECTROMAGNETIC COMPATIBILITY (EMC)

a - for motors only

According to amendment 1 of IEC 60034-1, induction motors are not transmitters and do not produce interference (via carried or airborne signals) and therefore conform inherently to the essential requirements of the EMC directives.

b - for motors supplied by inverters (at fixed or variable frequency)

In this case, the motor is only a sub-assembly of a device which the system builder must ensure conforms to the essential requirements of the EMC directives.

APPLICATION OF LOW VOLTAGE DIRECTIVE 2006/95/EC

All motors are subject to this directive. The main requirements concern the protection of people, animals and property against risks caused by operation of the motors (see the commissioning and maintenance manual for precautions to be taken).

APPLICATION OF MACHINERY DIRECTIVE 2006/42/EC

All motors are designed to be integrated in a device subject to the machinery directive.

MARKING OF PRODUCTS

The fact that motors comply with the essential requirements of the Directives is shown by the **CE** mark on their nameplates and/or packaging and documentation.

Construction Bearings and Bearing Life

DEFINITIONS

LOAD RATINGS

Static load rating C_0 :

This is the load for which permanent deformation at point of contact between a bearing race and the ball (or roller) with the heaviest load reaches 0.01% of the diameter of the ball (or roller).

Dynamic load rating C :

This is the load (constant in intensity and direction) for which the nominal lifetime of the bearing will reach 1 million revolutions.

The static load rating C_0 and dynamic load rating C are obtained for each bearing by following the method in ISO 281.

LIFETIME

The lifetime of a bearing is the number of revolutions (or number of operating hours at a constant speed) that the bearing can accomplish before the first signs of fatigue (spalling) begin to appear on a ring, ball or roller.

Nominal lifetime L_{10h}

According to the ISO recommendations, the nominal lifetime is the length of time completed or exceeded by 90% of apparently identical bearings operating under the conditions specified by the manufacturer.

Note: The majority of bearings last much longer than the nominal lifetime; the average lifetime achieved or exceeded by 50% of bearings is around 5 times longer than the nominal lifetime.

DETERMINATION OF NOMINAL LIFETIME

Constant load and speed of rotation

The nominal lifetime of a bearing expressed in operating hours L_{10h} , the dynamic load rating C expressed in daN and the applied loads (radial load F_r and axial load F_a) are related by the following equation:

$$L_{10h} = \frac{1000000}{60 \cdot N} \cdot \left(\frac{C}{P}\right)^p$$

where N = speed of rotation (rpm)

P ($P = X F_r + Y F_a$): dynamic load equivalent (F_r, F_a, P in daN)

p : exponent which is a function of the contact between the races and balls (or rollers)

$p = 3$ for ball bearings

$p = 10/3$ for roller bearings

The formulae that give Equivalent Dynamic Load (values of factors X and Y) for different types of bearing can be obtained from their respective manufacturers.

Variable load and speed of rotation

For bearings with periodically variable load and speed, the nominal lifetime is established using the equation:

$$L_{10h} = \frac{1000000}{60 \cdot N_m} \cdot \left(\frac{C}{P_m}\right)^p$$

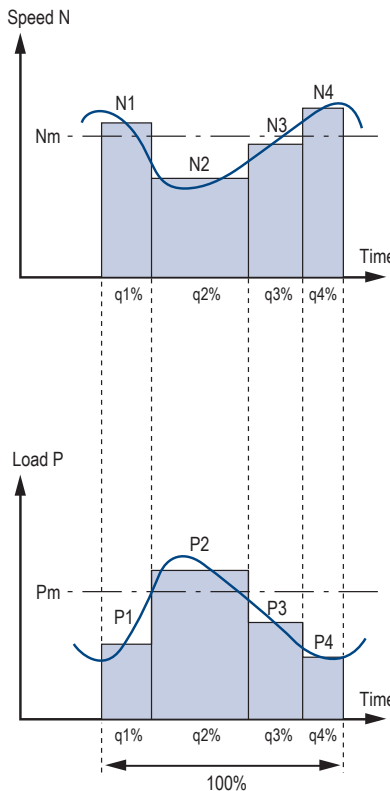

N_m : average speed of rotation

$$N_m = N_1 \cdot \frac{q_1}{100} + N_2 \cdot \frac{q_2}{100} + \dots (\text{min}^{-1})$$

P_m : average equivalent dynamic load

$$P_m = \sqrt[p]{P_1^p \cdot \left(\frac{N_1}{N_m}\right) \cdot \frac{q_1}{100} + P_2^p \cdot \left(\frac{N_2}{N_m}\right) \cdot \frac{q_2}{100} + \dots (\text{daN})}$$

with q_1, q_2, \dots as a %

Nominal lifetime L_{10h} is applicable to bearings made of bearing steel and normal operating conditions (lubricating film present, no contamination, correctly fitted, etc.).

Situations and data differing from these conditions will lead to either a reduction or an increase in lifetime compared to the nominal lifetime.

Corrected nominal lifetime

If the ISO recommendations (DIN ISO 281) are used, improvements to bearing steel, manufacturing processes and the effects of operating conditions can be included in the nominal lifetime calculation.

The theoretical pre-fatigue lifetime L_{nah} is thus calculated using the formula:

$$L_{nah} = a_1 a_2 a_3 L_{10h}$$

where:

a_1 : failure probability factor

a_2 : factor for the characteristics and tempering of the steel

a_3 : factor for the operating conditions (lubricant quality, temperature, speed of rotation, etc.).

Construction Lubrication and Maintenance of Bearings

ROLE OF THE LUBRICANT

The principal role of the lubricant is to avoid direct contact between the metal parts in motion: balls or rollers, slip-rings, cages, etc. It also protects the bearing against wear and corrosion.

The quantity of lubricant needed by a bearing is normally quite small. There should be enough to provide good lubrication without undesirable overheating. As well as lubrication itself and the operating temperature, the amount of lubricant should be judged by considerations such as sealing and heat dissipation.

The lubricating power of a grease or an oil lessens with time owing to mechanical constraints and straightforward aging. Used or contaminated lubricants should therefore be replaced or topped up with new lubricant at regular intervals.

Bearings can be lubricated with grease, oil or, in certain cases, with a solid lubricant.

GREASING

A lubricating grease can be defined as a product of semi-fluid consistency obtained by the dispersion of a thickening agent in a lubricating fluid and that may contain several additives to give it particular properties.

Composition of a grease
Base oil: 85 to 97%
Thickener: 3 to 15%
Additives: 0 to 12%

THE BASE OIL LUBRICATES

The oil making up the grease is of **prime importance**. It is the oil that lubricates the moving parts by coating them with a protective film which prevents direct contact. The thickness of the lubricating film is directly linked to the viscosity of the oil, and the viscosity itself depends on temperature. The two main types used to make grease are mineral oils and synthetic oils. Mineral oils are suitable for normal applications in a range of temperatures from -30°C to +150°C.

Synthetic oils have the advantage of being effective in severe conditions (extreme variations of temperature, harsh chemical environments, etc.).

THE THICKENER GIVES THE GREASE CONSISTENCY

The more thickener a grease contains, the "harder" it will be. Grease consistency varies with the temperature. In falling temperatures, the grease hardens progressively, and the opposite happens when temperatures rise.

The consistency of a grease can be quantified using the NLGI (National Lubricating Grease Institute) classification. There are 9 NLGI grades, from 000 for the softest greases up to 6 for the hardest. Consistency is expressed by the depth to which a cone can be driven into a grease maintained at 25°C.

If we only consider the chemical nature of the thickener, lubricating greases fall into three major categories:

- **Conventional greases with a metallic soap base** (calcium, sodium, aluminum, lithium). Lithium soaps have several advantages over other metallic soaps: a high melting point (180° to 200°), good mechanical stability and good water-resistant properties.

- **Greases with a complex soap base.** The main advantage of this type of soap is a very high melting point (over 250°C).

- **Soapless greases.** The thickener is an inorganic compound, such as clay. Their main property is the absence of a melting point, which makes them practically non-liquefying.

ADDITIVES IMPROVE SOME PROPERTIES OF GREASES

Additives fall into two types, depending on whether or not they are soluble in the base oil.

The most common insoluble additives - graphite, molybdenum disulphide, talc, mica, etc., improve the friction characteristics between metal surfaces. They are therefore used in applications where heavy pressure is required.

The soluble additives are the same as those used in lubricating oils: antioxidants, anti-rust agents, etc.

LUBRICATION TYPE

The bearings are lubricated with a polyurea soap-based grease.

Operation Duty Cycle - Definitions

DUTY CYCLES (IEC 60034-1)

The typical duty cycles are described below:

1 - Continuous duty - Type S1

Operation at constant load of sufficient duration for thermal equilibrium to be reached (see figure 1).

2 - Short-time duty - Type S2

Operation at constant load during a given time, less than that required for thermal equilibrium to be reached, followed by a rest and de-energized period of sufficient duration to re-establish machine temperatures within 2 K of the coolant (see figure 2).

3 - Intermittent periodic duty - Type S3

A sequence of identical duty cycles, each consisting of a period of operation at constant load and a rest and de-energized period (see figure 3). Here, the cycle is such that the starting current does not significantly affect the temperature rise (see figure 3).

4 - Intermittent periodic duty with starting - Type S4

A sequence of identical duty cycles, each consisting of a significant starting period, a period of operation at constant load and a rest and de-energized period (see figure 4).

5 - Intermittent periodic duty with electrical braking - Type S5

A sequence of periodic duty cycles, each consisting of a starting period, a period of operation at constant load, a period of rapid electrical braking and a rest and de-energized period (see figure 5).

6 - Periodic continuous duty with intermittent load - Type S6

A sequence of identical duty cycles, each consisting of a period of operation at constant load and a period of operation at no load. There is no rest and de-energized period (see figure 6).

7 - Periodic continuous duty with electrical braking - Type S7

A sequence of identical duty cycles, each consisting of a starting period, a period of operation at constant load and a period of electrical braking. There is no rest and de-energized period (see figure 7).

8 - Periodic continuous duty with related changes of load and speed - Type S8

A sequence of identical duty cycles, each consisting of a period of operation at constant load corresponding to a predetermined rotation speed, followed by one or more periods of operation at other constant loads

corresponding to different rotation speeds (in induction motors, this can be done by changing the number of poles). There is no rest and de-energized period (see figure 8).

9 - Duty with non-periodic variations in load and speed - Type S9

This is a duty in which the load and speed generally vary non-periodically within the permissible operating range. This duty frequently includes applied overloads which may be much higher than the full load or loads (see figure 9).

Note - For this type of duty, the appropriate full load values must be used as the basis for calculating overload.

10 - Operation at discrete constant loads - Type S10

This duty consists of a maximum of 4 discrete load values (or equivalent loads), each value being applied for sufficient time for the machine to reach thermal equilibrium. The minimum load during a load cycle may be zero (no-load operation or rest and de-energized period) (see figure 10).

Note: Only S1 duty is affected by IEC 60034-30-1

Fig. 1. - Continuous duty, Type S1.

Fig. 2. - Short-time duty,

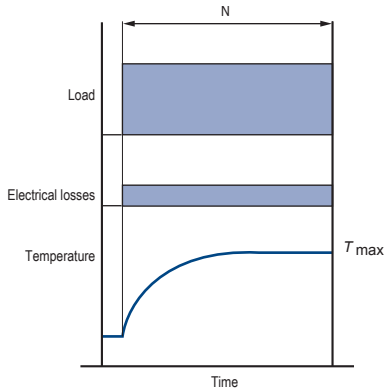

N = operation at constant load
T_{max} = maximum temperature attained

Type S2.
Fig. 3. - Intermittent periodic duty, Type S3.

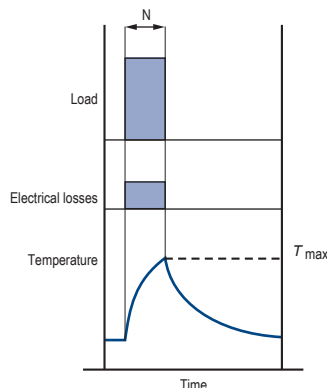

N = operation at constant load
T_{max} = maximum temperature attained

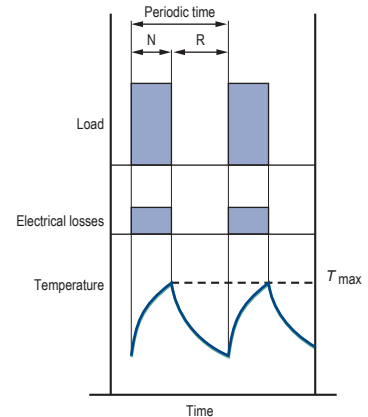

N = operation at constant load
R = rest
T_{max} = maximum temperature attained
Operating factor (%) = $\frac{N}{N + R} \cdot 100$

Operation Duty Cycle - Definitions

Fig. 4. - Intermittent periodic duty with starting. Type S4.

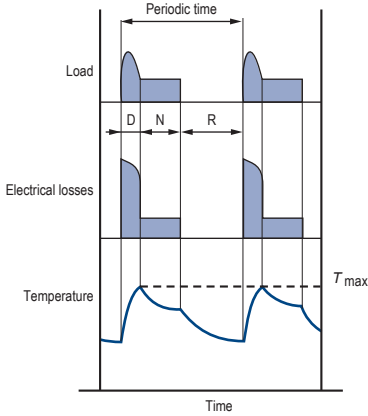

D = starting
 N = operation at constant load
 R = rest
 T_{max} = maximum temperature attained during cycle
 Operating factor (%) = $\frac{D + N}{N + R + D} \cdot 100$

Fig. 5. - Intermittent periodic duty with electrical braking. Type S5.

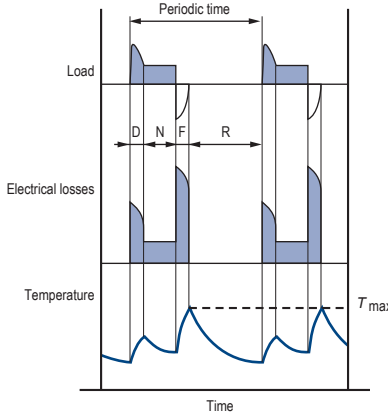

D = starting
 N = operation at constant load
 F = electrical braking
 R = rest
 T_{max} = maximum temperature attained during cycle
 Operating factor (%) = $\frac{D + N + F}{D + N + F + R} \cdot 100$

Fig. 6. - Periodic continuous duty with intermittent load. Type S6.

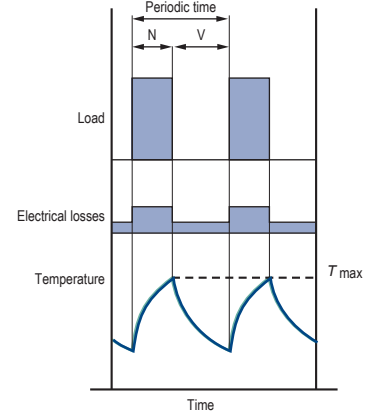

N = operation at constant load
 V = no-load operation
 T_{max} = maximum temperature attained during cycle
 Operating factor (%) = $\frac{N}{N + V} \cdot 100$

Fig. 7. - Periodic continuous duty with electrical braking. Type S7.

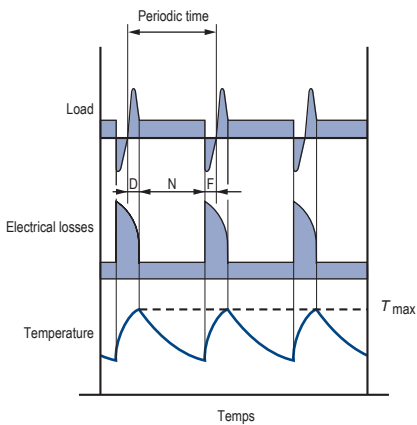

D = starting
 N = operation at constant load
 F = electrical braking
 T_{max} = maximum temperature attained during cycle
 Operating factor = 1

Fig. 8. - Periodic continuous duty with related changes of load and speed. Type S8.

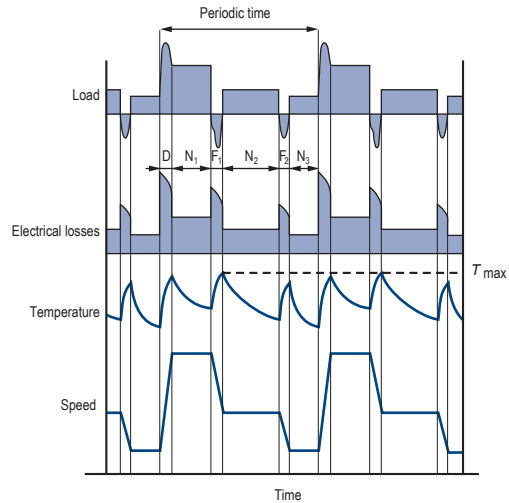

F₁F₂ = electrical braking
 D = starting
 N₁N₂N₃ = operation at constant loads
 T_{max} = maximum temperature attained during cycle
 Operating factor = $\frac{D + N_1}{D + N_1 + F_1 + N_2 + F_2 + N_3} \cdot 100\%$
 $\frac{F_1 + N_2}{D + N_1 + F_1 + N_2 + F_2 + N_3} \cdot 100\%$
 $\frac{F_2 + N_3}{D + N_1 + F_1 + N_2 + F_2 + N_3} \cdot 100\%$

Operation Duty Cycle - Definitions

Fig. 9 - Duty with non-periodic variations in load and speed. Type S9.

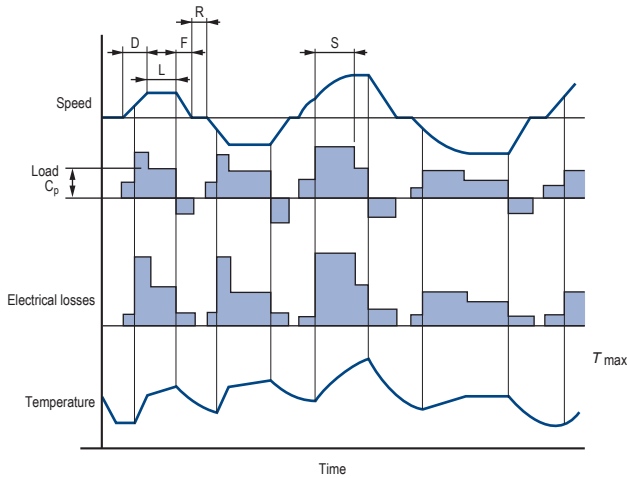

- D = starting
- L = operation at variable loads
- F = electrical braking
- R = rest
- S = operation at overload
- C_p = full load
- T_{max} = maximum temperature attained

Fig. 10 - Duty at discrete constant loads. Type S10.

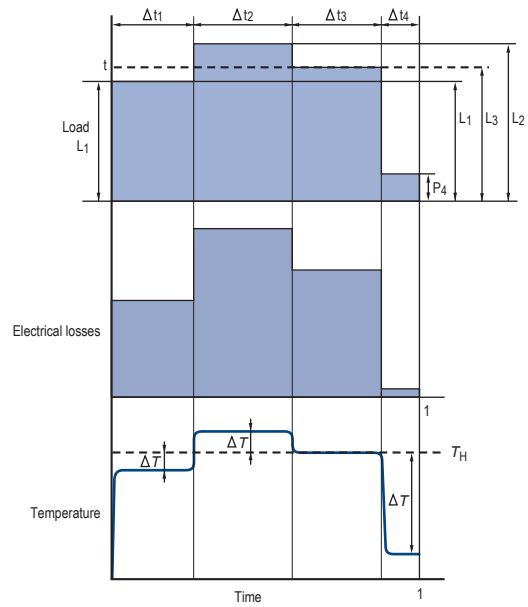

- L = load
- N = rated power for type S1 duty
- $p = p / \frac{L}{N} = \text{reduced load}$
- t = time
- T_p = total cycle time
- t_i = discrete period within a cycle
- $\Delta t_i = t_i / T_p = \text{relative duration of period within a cycle}$
- P_u = electrical losses
- H_N = temperature at rated power for type S1 duty
- $\Delta H_i = \text{increase or decrease in temperature rise during the } i\text{th period of the cycle}$

Power is determined according to duty cycle. See “Operation” chapter,
“Power - Torque - Efficiency - Power Factor (cos Φ)” section.

For duty types between S3 and S8 inclusive, the default cycle is 10 minutes unless otherwise stated.

Operation Supply Voltage

REGULATIONS AND STANDARDS

The IEC 60038 standard gives the European reference voltage as 230/400 V three-phase and 230 V single-phase, with a tolerance of $\pm 10\%$.

The tolerances usually permitted for power supply sources are indicated below:

- Maximum voltage drop between customer delivery point and customer usage point: 4%.

• Variation in frequency around the rated frequency:

- continuous operation: $\pm 1\%$
- transient state: $\pm 2\%$

• Three-phase Mains supply phase voltage imbalance:

- zero-sequence component and/or negative phase sequence component compared to positive phase sequence component: $< 2\%$

The motors in this catalog are designed for use on the European power supply of 400 V $\pm 10\%$ - 50 Hz.

All other voltages and frequencies are available on request.

EFFECTS ON MOTOR PERFORMANCE

VOLTAGE RANGE

The characteristics of motors will of course vary with a corresponding variation in voltage of $\pm 10\%$ around the rated value.

An approximation of these variations is given in the table below.

	Voltage variation as a %				
	UN-10%	UN-5%	UN	UN+5%	UN+10%
Torque curve	0.81	0.90	1	1.10	1.21
Slip	1.23	1.11	1	0.91	0.83
Rated current	1.10	1.05	1	0.98	0.98
Rated efficiency	0.97	0.98	1	1.00	0.98
Rated power factor (cos φ)	1.03	1.02	1	0.97	0.94
Starting current	0.90	0.95	1	1.05	1.10
Nominal temperature rise	1.18	1.05*	1	1*	1.10
P (Watt) no-load	0.85	0.92	1	1.12	1.25
Q (reactive VA) no-load	0.81	0.9	1	1.1	1.21

* According to standard IEC 60034-1, the additional temperature rise must not exceed 10 K within $\pm 5\%$ of UN.

Operation Supply Voltage

SIMULTANEOUS VARIATION OF VOLTAGE AND FREQUENCY

Within the tolerances defined in IEC guide 106, machine input and performance are unaffected if the variations are of the same polarity and the voltage/frequency ratio U/f remains constant.

If this is not the case, variations in performance are significant and require the machine specification to be changed.

Variation in main motor parameters (approx.) within the limits defined in IEC Guide 106.

U/f	P_u	M	N	$\cos \varphi$	Efficiency
Constant	$P_u \frac{f}{f}$	M	$N \frac{f}{f}$	$\cos \varphi$ unchanged	Efficiency unchanged
Variable	$P_u \left(\frac{U'/U}{f/f}\right)^2$	$M \left(\frac{U'/U}{f/f}\right)^2$	$N \frac{f}{f}$	Dependent on the machine saturation state	

M = minimum and maximum values of starting torque.

USE OF 400 V - 50 HZ MOTORS ON 460 V - 60 HZ SUPPLIES

For output power at 60 Hz equal to output power at 50 Hz, the main characteristics are modified according to the following variations:

- Efficiency increases by 0.5 - 1.5%
- Power factor decreases by 0.5 to 1.5%

- Rated current decreases by 0 to 5%
- IS/IN increases by around 10%
- Slip and rated torque MN, MD/MN, M/MN remain more or less constant.

Comment:

For the North American markets, a different type of construction is needed to comply with the regulatory requirements.

USE ON SUPPLIES WITH U' VOLTAGES different from the voltages in the characteristics tables

In this case, the machine windings should be adapted.

As a result, only the current values will be changed and become:

$$I' = I_{400V} \times \frac{400}{U'}$$

PHASE VOLTAGE IMBALANCE

The phase imbalance is calculated as follows:

$$\text{Phase voltage imbalance as a \%} = 100 \times \frac{\text{maximum difference in voltage compared to the average voltage value}}{\text{average voltage value}}$$

The effect on motor performance is summarized in the table opposite.

If this imbalance is known before the motor is purchased, it is advisable, in

order to establish the type of motor required, to apply the derating specified in standard IEC 60892, illustrated on the graph opposite.

Percentage imbalance	0	2	3.5	5
Stator current	100	101	104	107.5
Increase in losses %	0	4	12.5	25
Temperature rise	1	1.05	1.14	1.28

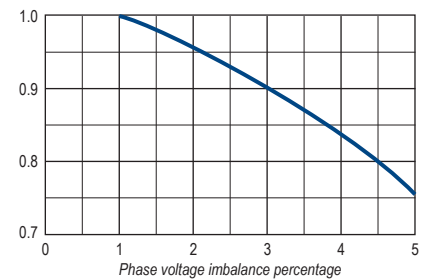

PHASE CURRENT IMBALANCE

Voltage imbalances induce current imbalances. Natural lack of symmetry due to the construction also induces current imbalances.

The chart opposite shows the ratios in which the negative phase component is equal to 5% (and 3%) of the positive phase component in three-phase current supplies without zero components (neutral absent or not connected).

Inside the curve, the negative phase component is lower than 5% (and 3%).

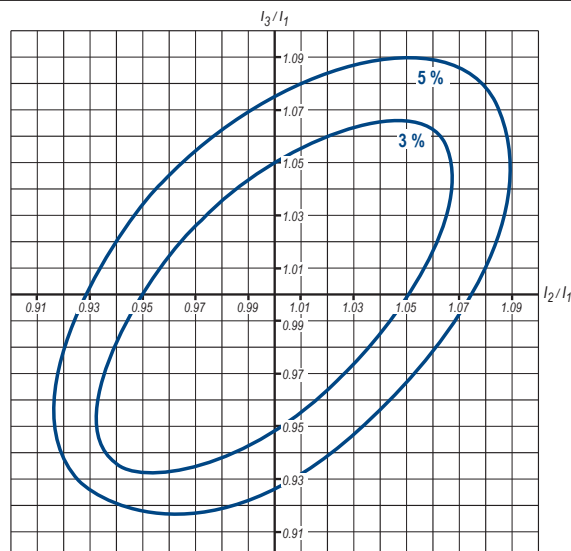

Operation

Insulation Class - Temperature Rise and Thermal Reserve

INSULATION CLASS

The machines in this catalog have been designed with a class F insulation system for the windings.

Class F allows for temperature rises of 105 K (measured by the resistance variation method) and maximum temperatures at the hot spots in the machine of 155°C (Ref. IEC 60085 and IEC 60034-1).

Complete impregnation with tropicalized varnish of thermal class 180°C gives protection against attacks from the environment, such as: up to 95% relative humidity, interference, etc.

For special constructions, the winding is class H and/or impregnated with special varnishes which enable it to operate in conditions of high temperatures with relative air humidity of up to 100%.

The insulation of the windings is monitored in two ways:

a - Dielectric inspection which involves checking the leakage current, at an applied voltage of $(2U + 1000)$ V, in conditions complying with standard IEC 60034-1 (systematic test).

b - Monitoring the insulation resistance between the windings and between the windings and the ground (sampling test) at a D.C. voltage of 500 V or 1,000 V.

TEMPERATURE RISE AND THERMAL RESERVE

Leroy-Somer liquid-cooled motors are built to have a maximum winding temperature rise of 80 K under normal operating conditions (ambient temperature 40°C, altitude below 1000 m, rated voltage and frequency, rated load and water inlet temperature < 38°C).

The result is a thermal reserve linked to the following factors:

- A difference of 25 K between the nominal temperature rise (U_n, F_n, P_n) and the permissible temperature rise (105 K) for class F insulation.

- A difference of 10°C minimum at the voltage limits.

In IEC 60034-1 and 60034-2, temperature rise ($\Delta\theta$), is calculated using the winding resistance variation method, with the formula:

$$\Delta T = \frac{R_2 - R_1}{R_1} (235 + T_1) + (T_1 - T_2)$$

R_1 : cold resistance measured at ambient temperature T_1

R_2 : stabilized hot resistance measured at ambient temperature T_2

235: coefficient for a copper winding (for an aluminum winding, the coefficient is 225).

Temperature rise (ΔT^*) and maximum temperatures at hot spots (T_{max}) for insulation classes (IEC 60034-1).

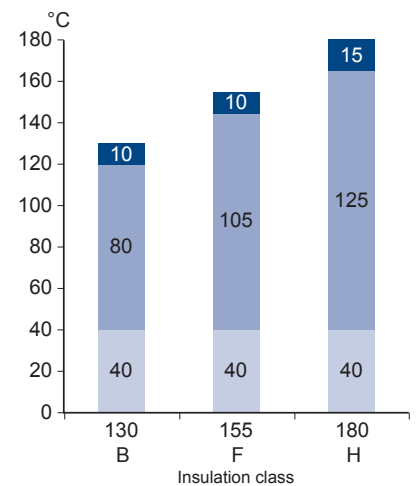

- Temperature rise at hot spots T_{max}
- Temperature rise
- Ambient temperature

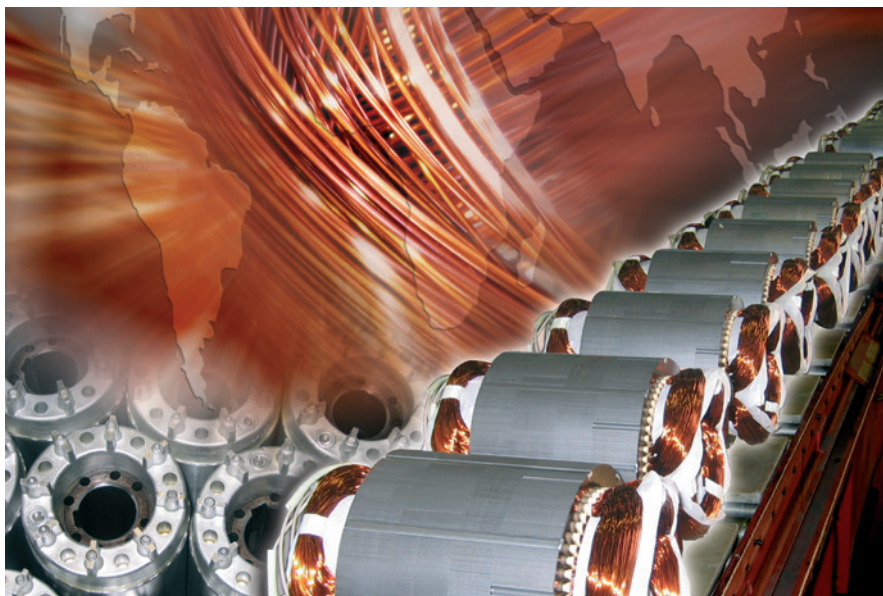

Operation

Starting Times and Starting Current

PERMISSIBLE STARTING TIMES AND LOCKED ROTOR TIMES

The starting times calculated must remain within the limits of the graph opposite which defines maximum starting times in relation to the starting current. Two successive cold starts are allowed and one hot start (after thermal stabilization at rated power). Between each successive start, a stop of 15 minutes must be observed.

Permissible motor starting time as a function of the ratio I_D/I_N .

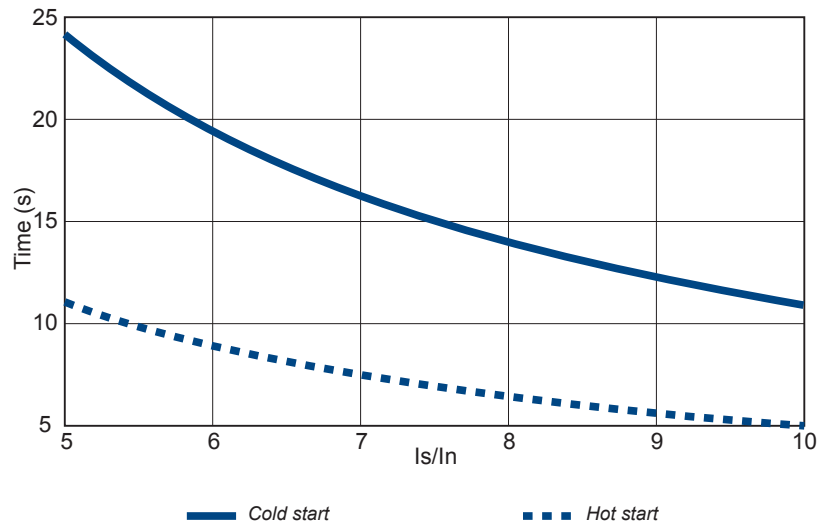

Note: For specific requests accurate calculations can be made.

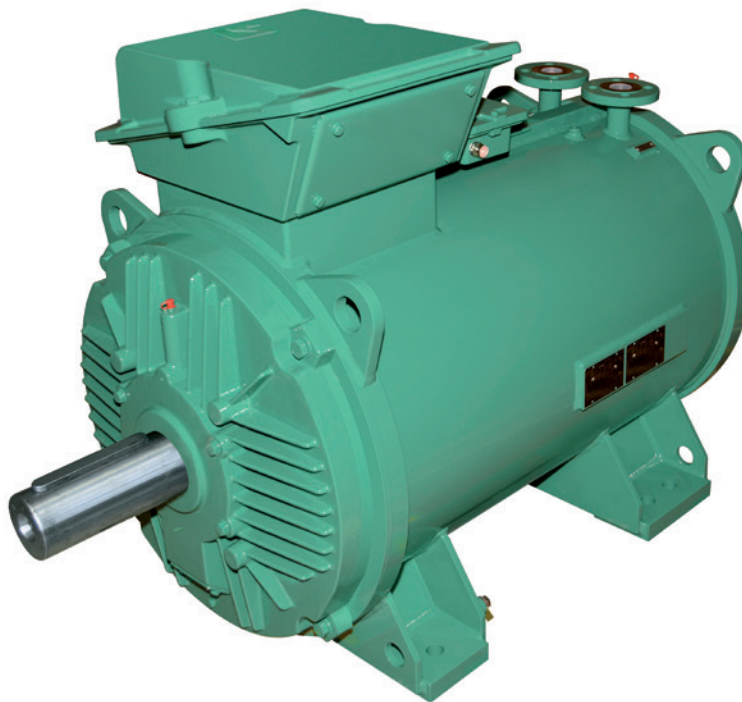

Operation

Power - Torque - Efficiency - Power Factor (Cos φ)

DEFINITIONS

The output power (P_u) at the motor shaft is linked to the torque (M) by the equation:

$$P_u = M \cdot \omega$$

where P_u is in W, M is in N.m, ω is in rad/s and where ω is expressed as a function of the speed of rotation in rpm by the equation:

$$\omega = 2\pi \cdot N/60$$

The active power (P) drawn from the

A.C. supply is expressed as a function of the apparent power (S) and the reactive power (Q) by the equation:

$$S = \sqrt{P^2 + Q^2}$$

(S in VA, P in W and Q in VAR)

The power P is linked to the output power P_u by the equation:

$$P = \frac{P_u}{\eta}$$

where η is the efficiency of the machine.

The output power P_u at the motor shaft is expressed as a function of the phase-to-phase A.C. supply voltage (U in Volts), of the line current absorbed (I in Amps) by the equation:

$$P_u = U \cdot I \cdot \sqrt{3} \cdot \cos\phi \cdot \eta$$

where $\cos\phi$ is the power factor found from the ratio:

$$\cos\phi = \frac{P}{S}$$

EFFICIENCY

In accordance with the agreements signed at international conferences from Rio to Paris (COP21), the new generation of liquid-cooled motors has been designed to improve efficiency by reducing atmospheric pollution (carbon dioxide).

The improved efficiency of low-voltage industrial motors (representing around 50% of installed power in industry) has had a large impact on energy consumption.

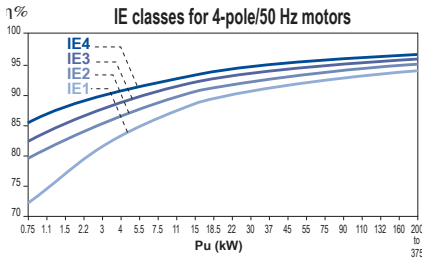

IEC 60034-30-1 defines four efficiency classes for 2, 4, 6 and 8-pole motors from 0.12 to 1000 kW.



Advantages of improvement in efficiency:

Motor characteristics	Effects on the motor	Customer benefits
Increase in efficiency and in power factor	-	Lower operating costs. Longer service life (x2 or 3). Better return on investment
Reduced noise	-	Improved working conditions
Reduced vibration	-	Quiet operation and longer service life of equipment being driven
Reduced temperature rise	Longer service life of fragile components (insulation system components, greased bearings)	Reduced number of operating incidents and reduced maintenance costs
	Increased capability of instantaneous or extended overloads	Wider field of applications (voltages, altitude, ambient temperature, etc.)

Operation

Power - Torque - Efficiency - Power Factor (Cos φ)

RATED POWER P_N IN RELATION TO DUTY CYCLE

GENERAL RULES FOR STANDARD MOTORS

$$P_n = \sqrt{\frac{n \times t_d \times [I_D/I_n \times P]^2 + (3600 - n \times t_d)P^2 \times \text{fdm}}{3600}}$$

Iterative calculation where:

- t_d (s) starting time achieved with motor rated $P_{(w)}$
- n number of (equivalent) starts per hour
- fdm (OF) operating factor (decimal)
- I_D/I_n current demand for motor rated P
- $P_{u(w)}$ motor output power during the duty cycle
OF (in decimal), operating factor
- $P_{(w)}$ motor rated power selected for the calculation

S1	OF = 1; $n \leq 4$
S2	$n = 1$ operating life determined by specification (S_p)
S3	OF according to S_p ; $n \sim 0$ (no effect of starting on temperature rise)
S4	OF according to S_p ; n according to S_p ; t_d , P_u , P according to S_p (replace n with $4n$ in the above formula)
S5	OF according to S_p ; $n = n$ starts + 3 n braking operations = $4n$; t_d , P_u , P according to S_p (replace n with $4n$ in the above formula)
S6	$P = \sqrt{\frac{\sum^n (P_i^2 \cdot t_i)}{\sum^n t_i}}$
S7	same formula as S5 but OF = 1
S8	at high speed, same formula as S1 at low speed, same formula as S5
S9	S8 duty formula after complete description of cycle with OF on each speed
S10	same formula as S6

In addition, see the warning regarding precautions to be taken. Variations in voltage and/or frequency greater than standard should also be taken into account. The application should also be taken into account (general at constant torque, centrifugal at quadratic torque, etc.).

DETERMINATION OF THE POWER IN INTERMITTENT DUTY CYCLES FOR ADAPTED MOTORS

RMS POWER IN INTERMITTENT DUTY

This is the rated power absorbed by the driven machine, usually defined by the manufacturer.

If the power absorbed by the machine varies during a cycle, the rms power P is calculated using the equation:

$$P = \sqrt{\frac{\sum^n (P_i^2 \cdot t_i)}{\sum^n t_i}} = \sqrt{\frac{P_1^2 \cdot t_1 + P_2^2 \cdot t_2 + \dots + P_n^2 \cdot t_n}{t_1 + t_2 + \dots + t_n}}$$

if, during the working time the absorbed power is:

P_1 for period t_1

P_2 for period t_2 P_n for period t_n

Power values lower than 0.5 P_N are replaced by 0.5 P_N in the calculation of rms power P (no-load operation is a special case).

Additionally, it is also necessary to check that for a particular motor of power P_N :

- the actual starting time is at most equal to 5 seconds
- the maximum output of the cycle does not exceed twice the rated output power P
- there is still sufficient accelerating torque during the starting period

Load factor (LF)

Expressed as a percentage, this is the ratio of the period of operating time with a load during the cycle to the total duration of the cycle where the motor is energized.

Operating factor (OF)

Expressed as a percentage, this is the ratio of the motor power-on time during the cycle to the total cycle time, provided that the total cycle time is less than 10 minutes.

Starting class

Class: $n = nD + k \cdot nF + k' \cdot ni$

nD : number of complete starts per hour

nF : number of electrical braking operations per hour

“Electrical braking” means any braking directly involving the stator winding or the rotor winding:

- Regenerative braking (with frequency controller, multipole motor, etc.)
- Reverse-current braking (the most commonly used)
- D.C. injection braking

ni : number of pulses (incomplete starts up to a third of maximum speed) per hour

k and k' are constants determined as follows:

	k	k'
Cage induction motors	3	0.5

- Reversing the direction of rotation involves braking (usually electrical) and starting.
- Braking with Leroy-Somer electromechanical brakes, as with any other brakes that are independent of the motor, does not constitute electrical braking in the sense described above.

Operation

Power - Torque - Efficiency - Power Factor (Cos φ)

CALCULATING DERATING

Input criteria (load)

- rms power during the cycle = P
- Moment of inertia related to the speed of the motor: J_e
- Operating factor = OF
- Class of starts per hour = n
- Resistive torque during starting = M_r

Selection in catalog

- Motor rated power = PN
- Starting current I_d , $\cos\phi_D$
- Moment of inertia of rotor J_r
- Average starting torque M_{mot}
- Efficiency at PN (η_{PN}) and at P (η_P)

Calculations

- Starting time:

$$t_d = \frac{\pi}{30} \cdot N \cdot \frac{(J_e + J_r)}{M_{mot} - M_r}$$

- Cumulative starting time per hour:
 $n \times t_d$

- Energy to be dissipated per hour during starts = sum of the energy dissipated in the rotor (= inertia acceleration energy) and the energy dissipated in the stator during the cumulative starting time per hour:

$$E_d = \frac{1}{2} (J_e + J_r) \left(\frac{\pi \cdot N}{30} \right)^2 \times n + n \times t_d \sqrt{3} U I_d \cos\phi_d$$

- Energy to be dissipated during operation

$$E_f = P \cdot (1 - \eta_P) \cdot [(OF) \times 3600 - n \times t_d]$$

- Energy that the motor can dissipate at rated power with the Operating Factor for Intermittent Duty.

$$E_m = (OF) \cdot 3600 \cdot PN \cdot (1 - \eta_{PN})$$

- (The heat dissipated when the motor is at rest can be ignored).

Dimensioning is correct if the following relationship is verified =

$$E_m \geq E_d + E_f$$

If the sum of $E_d + E_f$ is lower than $0.75 E_m$, check whether a motor with the next lowest power would be more suitable.

EQUIVALENT THERMAL CONSTANT

The equivalent thermal constant enables the machine cooling time to be predetermined.

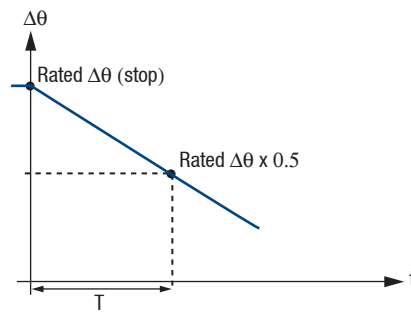

$$\text{Thermal constant} = \frac{T}{\ln 2} = 1.44 T$$

Cooling curve $\Delta\theta = f(t)$

where:

$\Delta\theta$ = temperature rise in S1 duty

T = time taken to go from the nominal temperature rise to half its value

t = time

ln = natural logarithm

TRANSIENT OVERLOAD AFTER OPERATION IN TYPE S1 DUTY CYCLE

At rated voltage and frequency, the motors can withstand an overload of:
140% for 10" maximum.
120% for 5' maximum, once an hour.

However, it is necessary to ensure that the maximum torque is much greater than 1.5 times the rated torque corresponding to the overload.

INFLUENCE OF LOAD ON EFFICIENCY AND THE COS φ

See the selection data.

Oversizing motors in a number of applications causes them to operate at about 3/4 load, resulting in optimum motor efficiency.

Operation Noise Level

NOISE EMITTED BY ROTATING MACHINES

In a compressible medium, the mechanical vibrations of an elastic body create pressure waves which are characterized by their amplitude and frequency. The pressure waves constitute an audible noise if they have a frequency of between 16 Hz and 16,000 Hz.

Noise is measured by a microphone linked to a frequency analyzer. Measurements are taken in an anechoic chamber on machines at no-load, and a sound pressure level L_p or a sound power level L_w can then be established. Measurement can also be carried out in situ on machines which may be on-load, using an acoustic intensity meter which can differentiate between sound sources and identify the sound emissions from the machine.

The concept of noise is linked to hearing. The auditory sensation is determined by integrating weighted frequency components with isosonic curves (giving a sensation of constant sound level) according to their intensity.

The weighting is carried out on sound meters using filters whose bandwidth takes into account, to a certain extent, the physiology of the human ear:

Filter A: used for low and medium noise levels. High attenuation, narrow bandwidth.

Filter B: used for very high noise levels. Wide bandwidth.

Filter C: very low attenuation over the whole of the audible frequency range.

Filter A is used most frequently for sound levels emitted by rotating machinery. It is this filter which has been used to establish the standardized characteristics.

A few basic definitions:

The unit of reference is the bel, and the sub-multiple decibel dB is used here.

Sound pressure level in dB

$$L_p = 20 \log_{10} \left(\frac{P}{P_0} \right) \quad p_0 = 2 \cdot 10^{-5} \text{ Pa}$$

Sound power level in (dB)

$$L_w = 10 \log_{10} \left(\frac{P}{P_0} \right) \quad p_0 = 10^{-12} \text{ W}$$

Sound intensity level in dB

$$L_w = 10 \log_{10} \left(\frac{I}{I_0} \right) \quad I_0 = 10^{-12} \text{ W/m}^2$$

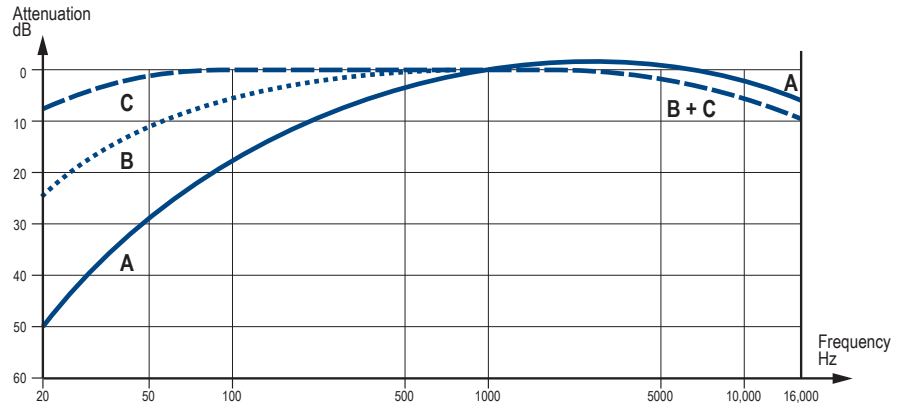

CORRECTION OF MEASUREMENTS

For differences of less than 10 dB between 2 sound sources or where there is background noise, corrections can be made by addition or subtraction using the rules below.

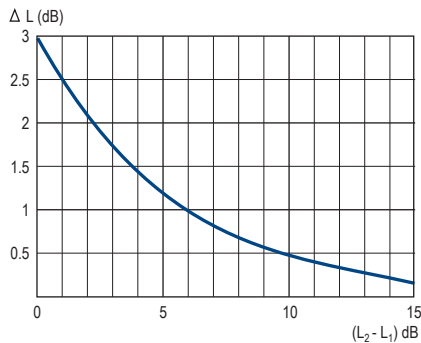

Addition of levels

If L_1 and L_2 are the separately measured levels ($L_2 \geq L_1$), the resulting sound level L_R will be obtained by the formula:

$$L_R = L_2 + \Delta L$$

ΔL is found by using the curve above.

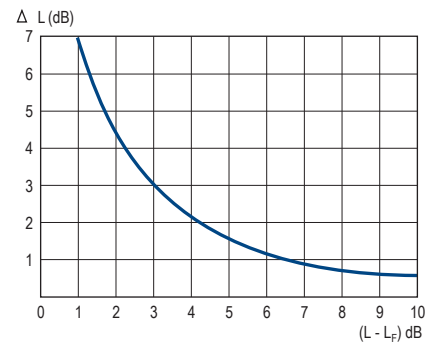

Subtraction of levels*

This is most commonly used to eliminate background noise from measurements taken in a "noisy" environment.

If L is the measured level and L_f the background noise level, the actual sound level L_R will be obtained by the calculation:

$$L_R = L - \Delta L$$

ΔL is found by using the curve above.

*This method is the one normally used for measuring sound power and pressure levels. It is also an integral part of sound intensity measurement.

Operation Weighted Sound Level [dB(A)]

Under IEC 60034-9, the guaranteed values are given for a machine operating at no-load under normal supply conditions (IEC 60034-1), in the actual operating position, or sometimes in the direction of rotation as specified in the design.

This being the case, standardized sound power level limits are shown for the values obtained for the machines described in this catalog.

(Measurements were taken in conformity with standard ISO 1680).

Expressed as sound power level (L_w) according to the standard, the level of sound is also shown as sound pressure level (L_p) in the selection data.

The maximum standard tolerance for all these values is + 3 dB(A).



The noise levels of the motors in this catalog are indicated in the selection tables.

Operation Vibrations

VIBRATION LEVELS - BALANCING

Inaccuracies due to construction (magnetic, mechanical and air-flow) lead to sinusoidal (or pseudo-sinusoidal) vibrations over a wide range of frequencies. Other sources of vibration can also affect motor operation: such as poor mounting, incorrect drive coupling, end shield misalignment, etc.

We shall first of all look at the vibrations emitted at the operating frequency, corresponding to an unbalanced load, whose amplitude swamps all other frequencies and on which the dynamic balancing of the mass in rotation has a decisive effect.

Under standard ISO 8821, rotating machines can be balanced with or without a key or with a half-key on the shaft extension.

Standard ISO 8821 requires the balancing method to be marked on the shaft extension as follows:

- half-key balancing: H, as standard
- full key balancing: F
- no-key balancing: N

However, if preferred, the table of vibration amplitudes can still be used (for measuring sinusoidal and similar vibrations).

The machines in this catalog are in vibration class level A - level B is available on request.

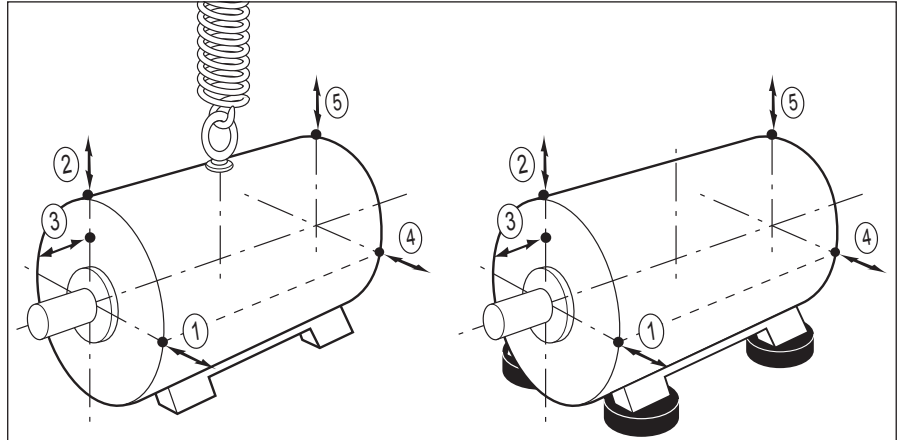

Measuring system for suspended machines

Measuring system for machines on flexible mountings

The measurement points quoted in the standards are indicated in the drawings above.

At each point, the results should be lower than those given in the tables below for each balancing class and only the highest value is to be taken as the “vibration level”.

MEASURED PARAMETERS

The vibration speed can be chosen as the variable to be measured. This is the speed at which the machine moves either side of its static position. It is measured in mm/s.

As the vibratory movements are complex and non-harmonic, it is the root mean square (rms) value of the speed of vibration which is used to express the vibration level.

Other variables that could also be measured are the vibratory displacement amplitude (in μm) or vibratory acceleration (in m/s^2).

If the vibratory displacement is measured against frequency, the measured value decreases with the frequency: high-frequency vibrations cannot be measured.

If the vibratory acceleration is measured, the measured value increases with the frequency: low-frequency vibrations cannot be measured.

The rms speed of vibration is the variable chosen by the standards.

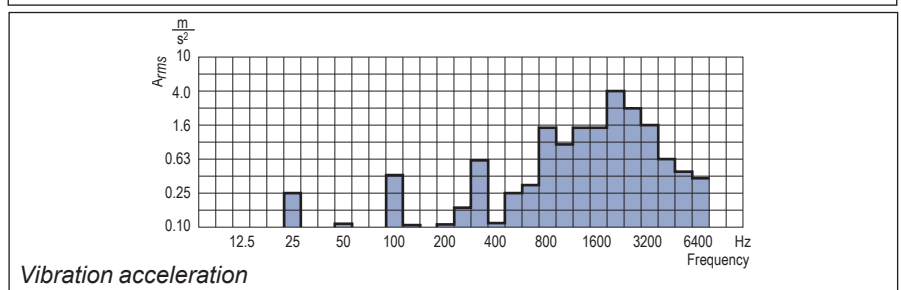
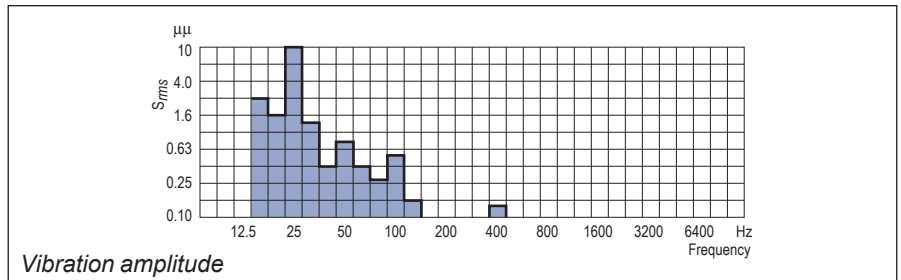
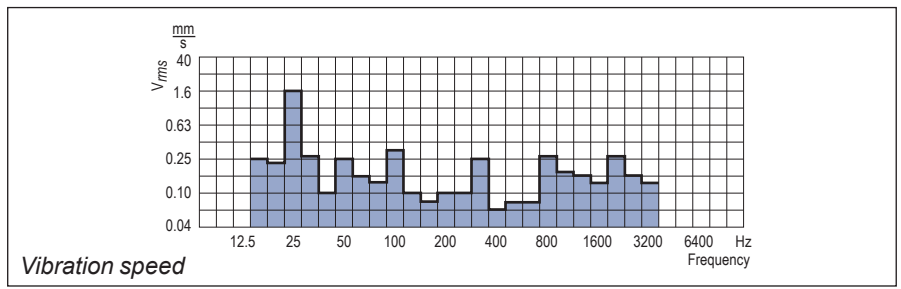

Operation Vibrations

BALANCING THE COUPLING

To find out the motor balancing type, look at its nameplate.

The motors are 1/2 key balancing as standard, unless otherwise indicated. The coupling balancing must be adapted to the motor balancing and the coupling adapted to the key length or any visible parts overhanging the key must be machined.

An adapted key can be used.

Important: Failure to comply with these recommendations can lead to premature wear of the bearings and can invalidate the manufacturer warranty.

COMPLIANT MOUNTINGS

Coupling adapted to the key length

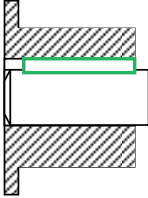

Machining of visible parts overhanging the key

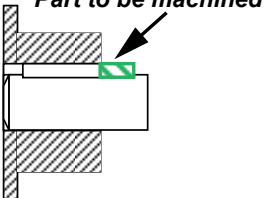

NON-COMPLIANT MOUNTING

Non-machined overhanging key
Coupling not adapted to the key length

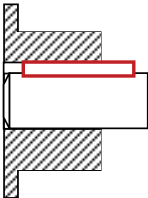

MAXIMUM VIBRATION MAGNITUDE LIMITS (RMS VALUES) IN TERMS OF DISPLACEMENT, SPEED AND ACCELERATION FOR A FRAME SIZE H (IEC 60034-14)

Level of vibration	H > 280		
	Displacement μm	Speed mm/s	Acceleration m/s^2
A	45	2.8	4.4
B	29	1.8	2.8

For large machines and special requirements with regard to vibration, balancing can be carried out *in situ* (finished assembly).

Prior consultation is essential, as the machine dimensions may be modified by the necessary addition of balancing disks mounted on the shaft extensions.

Operation Performance

THERMAL PROTECTION

Motors are protected by a manual or automatic thermal magnetic circuit-breaker, placed between the isolating switch and the motor. This circuit-breaker can in turn be protected by fuses.

With control by a drive, the motor thermal protection function can be performed by the drive.

These protection devices provide total protection of the motor against non-transient overloads. If a shorter reaction time is required, if you want to detect transient overloads, or if you wish to monitor temperature rises at “hot spots” in the motor or at strategic points in the installation for maintenance purposes, it would be advisable to install heat sensors at sensitive points. The various types are

shown in the table below, with a description of each. It must be emphasized that under no circumstances can these sensors be used to carry out direct regulation of the motor operating cycles.

BUILT-IN INDIRECT THERMAL PROTECTION

Type	Operating principle	Operating curve	Breaking capacity (A)	Protection provided	Mounting Number of devices*
Normally closed thermal protection PTO	Bimetallic strip, indirectly heated, with normally closed (NC) contact 		2.5 A at 250 V with $\cos \varphi$ 0.4	general surveillance for non-transient overloads	Mounting in control circuit 2 in series
Normally open thermal protection PTF	Bimetallic strip, indirectly heated, with normally open (NO) contact 		2.5 A at 250 V with $\cos \varphi$ 0,4	general surveillance for non-transient overloads	Mounting in control circuit 2 in parallel
Positive temperature coefficient thermistor PTC	Non-linear variable resistor, indirectly heated 		0	general surveillance for transient overloads	Mounted with associated relay in control circuit 3 in series
Temperature sensor KT Y	Resistance depends on the winding temperature		0	High accuracy continuous surveillance of key hot spots	Mounted in control boards with associated reading equipment (or recorder) 1 per hot spot
Thermocouples T ($T < 150^{\circ}\text{C}$) Copper Constantan K ($T < 1000^{\circ}\text{C}$) Copper-nickel	Peltier effect		0	Continuous surveillance of hot spots at regular intervals	Mounted in control boards with associated reading equipment (or recorder) 1 per hot spot
Platinum resistance thermometer PT 100	Linear variable resistor, indirectly heated		0	High accuracy continuous surveillance of key hot spots	Mounted in control boards with associated reading equipment (or recorder) 1 per hot spot

- NRT: nominal running temperature

- The NRTs are chosen according to the position of the sensor in the motor and the temperature rise class.

- KT Y 84/130 as standard.

* The number of devices relates to the winding protection.

FITTING THERMAL PROTECTION

- PTO or PTF, in the control circuits

- PTC, with relay, in the control circuits

- PT 100 or thermocouples, with reading equipment or recorder, in the installation control panel for continuous surveillance

ALARM AND EARLY WARNING

All protective equipment can be backed up by another type of protection (with different NRTs). The first device will then act as an early warning (light or sound signals given without shutting down the power circuits), and the second device will be an alarm (which shuts down the power circuits).

BUILT-IN DIRECT THERMAL PROTECTION

For low rated currents, bimetallic strip-type protection can be used. The line current passes through the strip, which shuts down or restores the supply circuit as necessary. The design of this type of protection allows for manual or automatic reset.

Operation

Starting Methods for Induction Motors

The two essential parameters for starting cage induction motors are:

- Starting torque
- Starting current

These two parameters and the resistive torque determine the starting time.

These three characteristics arise from the construction of cage induction motors. Depending on the driven load, it may be necessary to adjust these values to avoid torque surges on the load or current surges in the supply. There are essentially five different types of starting, which are:

- D.O.L. starting
- star/delta starting
- soft starting with auto-transformer
- soft starting with resistors
- electronic starting

The tables on the next few pages give the electrical outline diagrams, the effect on the characteristic curves, and a comparison of the respective advantages of each mode.

MOTORS WITH ASSOCIATED ELECTRONICS

Electronic starting modes control the voltage at the motor terminals throughout the entire starting phase, giving very gradual smooth starting.

DIGISTART D3 ELECTRONIC STARTER

Using the latest electronic control technologies to manage transient phases, the DIGISTART D3 range combines simplicity and user-friendliness while offering the user a high-performance, communicating electronic starter, and can achieve substantial energy savings.



- Range from 23 to 1600 A/400 V or 690 V
- Integrated bypass up to 1000 A:
 - Compact design: Up to 60% space saving
 - Energy saving
 - Reduced installation costs
- **Advanced control**
 - Starting and stopping adapt to the load automatically
 - Automatic parameter optimization by gradually learning the types of start
 - Special deceleration curve for pumping applications which derives from more than 15 years of Leroy-Somer's experience and expertise
- **High availability**
 - Able to operate with only two power components operational
 - Protection devices can be disabled to implement forced run mode (smoke extraction, fire pump, etc.)

- **Total protection**

- Continuous thermal modeling for maximum motor protection (even in the event of a power cut)
- Trips on configurable power thresholds
- Control of phase current imbalance
- Monitoring of motor temperatures and the environment with PTC or PT 100

- **Other functions**

- Installation trips in the event of an earth fault
- Connection to "Δ" motor (6-wire)
- Starter size at least one rating lower
- Automatic detection of motor connection
- Ideal for replacing Y/Δ starters

- **Communication**

Modbus RTU, DeviceNet, Profibus, Ethernet/IP, Profinet, Modbus TCP, USB

- **Simplicity of setup**

- 3 parameter-setting levels
- Preset configurations for pumps, fans, compressors, etc.
- Standard: access to the main parameters
- Advanced menu: access to all data
- Storage
- Time-stamped log of trips
- Energy consumption and operating conditions
- Latest modifications
- Simulate operation by forcing control
- Display the state of the inputs/outputs
- Counters: running time, number of starts, etc.

Operation
Starting Methods for Induction Motors

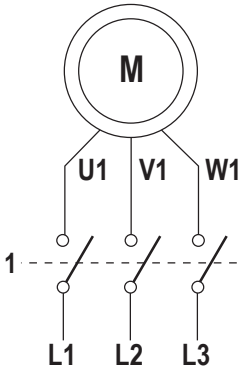
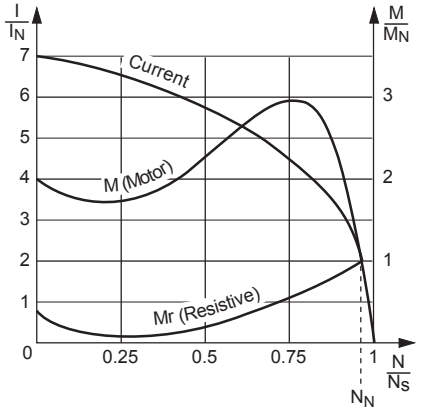
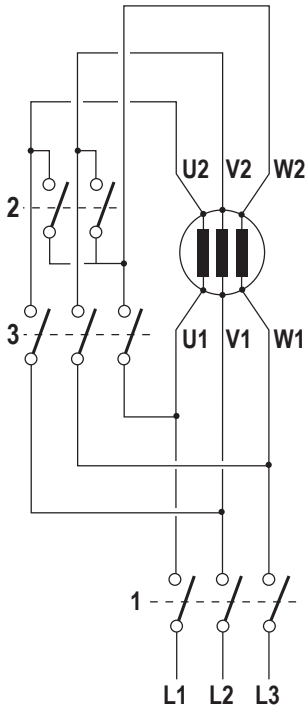
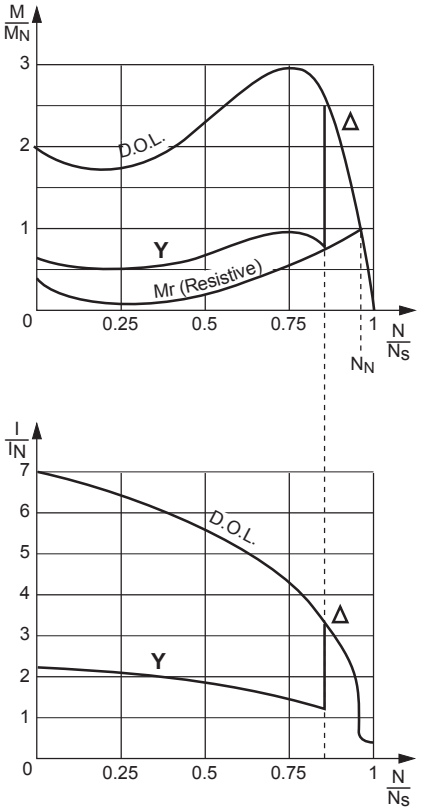
Mode	Outline diagram	Characteristic curves	Number of steps	Starting torque	Starting current	Advantages
D.O.L.			1	M_D	I_D	<ul style="list-style-type: none"> Simplicity of the equipment High torque Minimum starting time
Star-delta			2	$M_D/3$	$I_D/3$	<ul style="list-style-type: none"> Starting current divided by 3 Simple equipment 3 contactors including 1 two-pole

Operation

Starting Methods for Induction Motors

Mode	Outline diagram	Characteristic curves	Number of steps	Starting torque	Starting current	Advantages
Soft starting with auto transformer			$n \geq 3$	$K^2 \cdot M_D$	$K^2 \cdot I_D$	<p>Can be used to select the torque</p> <p>Current reduction proportional to that for the torque</p> <p>No power cut-off</p>
Soft starting with resistors			n	$K^2 \cdot M_D$	$K \cdot I_D$	<p>Can be used to select the torque or the current</p> <p>No power cut-off</p> <p>Modest additional cost (1 contactor per step)</p>

Operation
Starting Methods for Induction Motors

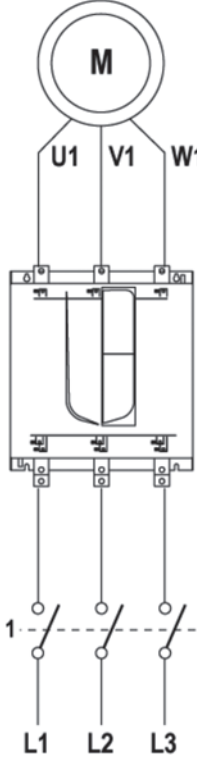
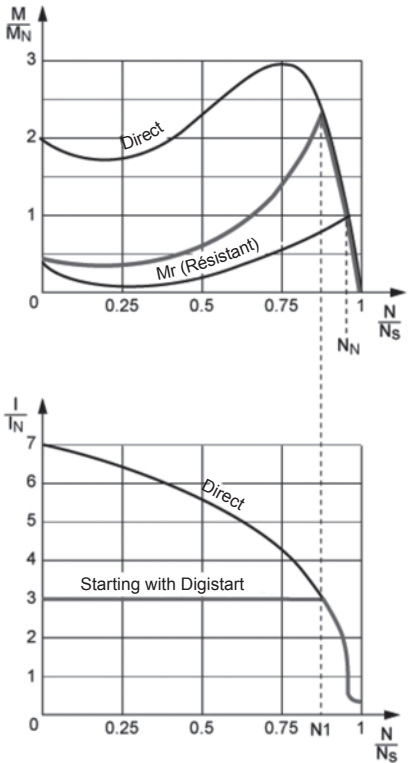
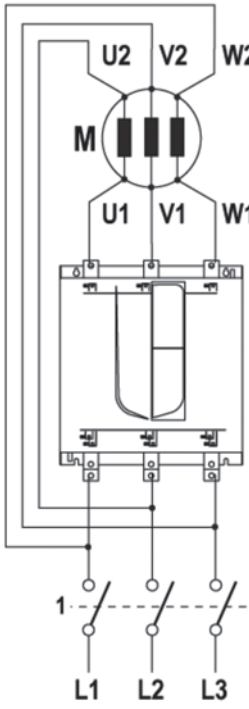
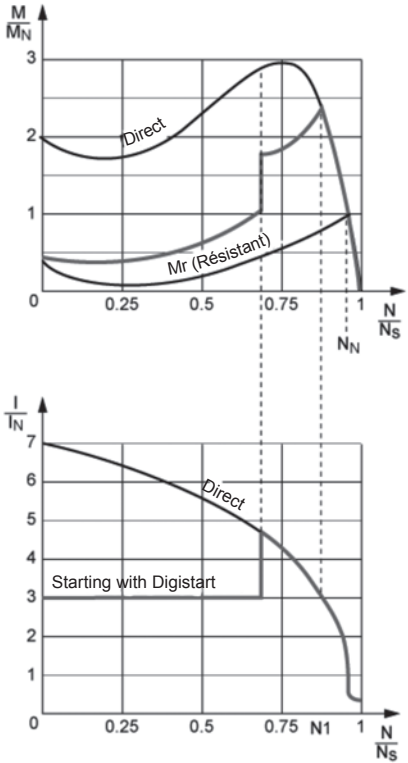
Mode	Outline diagram	Characteristic curves	Number of steps	Starting torque	Starting current	Advantages
DIGISTART D3				$K^2 M_D$	$K I_D$	<ul style="list-style-type: none"> Adjustable on site Choice of torque and current No power cut-off Smooth starting Compact size No maintenance High number of starts Digital Integrated motor and machine protection Serial link
DIGISTART D3 mode "6-wire"				$K^2 M_D$	$K I_D$	<ul style="list-style-type: none"> Same advantages as the above DIGISTART Current reduced by 35% Suitable for retrofitting on Y - Δ installations With or without bypass

Operation Braking

GENERAL

The braking torque is equal to the torque produced by the motor, increased by the resistive torque of the driven machine.

$$C_f = C_m + C_r$$

- C_f = braking torque
- C_m = motor torque
- C_r = resistive torque

Braking time, i.e. the time required for an induction motor to change from speed N to stop, is calculated by the formula:

$$T_f = \frac{\Pi \cdot J \cdot N}{30 \cdot C_f(\text{moy})}$$

- T_f (in s) = braking time
- J (in kgm^2) = moment of inertia
- N (in rpm) = speed of rotation
- C_f (av) (in N.m) = average braking torque during the time

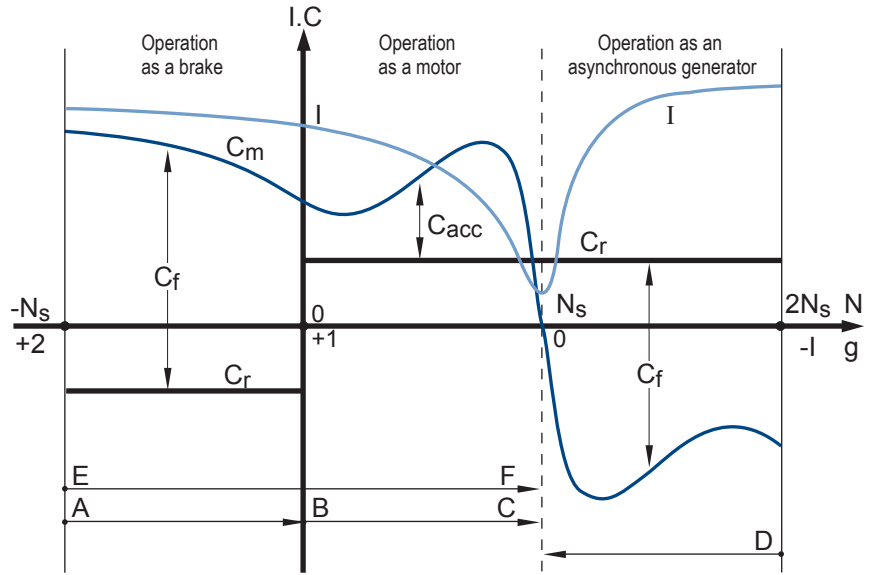

Curves $I = f(N)$, $C_m = f(N)$, $C_r = f(N)$, in the motor starting and braking zones.

- I = current absorbed
- C = torque value
- C_f = braking torque
- C_r = resistive torque
- C_m = motor torque
- N = speed of rotation
- g = slip
- N_s = synchronous speed
- AB = reverse-current braking
- BC = starting, acceleration
- DC = regenerative braking
- EF = reversal

REVERSE-CURRENT BRAKING

This method of braking is obtained by reversing two of the phases.

In general, an isolator disconnects the motor from the A.C. supply at the time the speed changes to $N=0$.

In cage induction motors, the average braking torque is usually greater than the starting torque.

Braking torque varies in different types of machine, as it depends on the rotor cage construction.

This braking method involves a large amount of absorbed current, more or less constant and slightly higher than the starting current.

Thermal stresses during braking are three times higher than during acceleration.

Accurate calculations are required for repetitive braking.

Note: The direction of rotation of a motor is changed by reverse-current braking and restarting.

Thermally, one reversal is the equivalent of 4 starts. Care must therefore be taken when choosing a machine.

D.C. INJECTION BRAKING

Operating stability can be a problem when reverse-current braking is used, due to the flattening out of the braking torque curve in the speed interval $(0, -N_s)$.

There is no such problem with D.C. injection braking: it can be used on both cage induction and slip-ring motors.

With this braking method, the induction motor is connected to the A.C. supply and braking occurs when the A.C. voltage is cut off and D.C. voltage is applied to the stator.

With control by a drive, a D.C. injection braking function is available as standard.

There are four different ways of connecting the windings to the D.C. voltage.

The D.C. voltage applied to the stator is usually supplied by a rectifier plugged into the A.C. supply.

Thermal stresses are approximately three times lower than for reverse-current braking.

The shape of the braking torque curve in the speed interval $(0, -N_s)$ is similar to that of the curve $C_m = f(N)$ and is obtained by changing the abscissa variable to $N_f = N_s - N$.

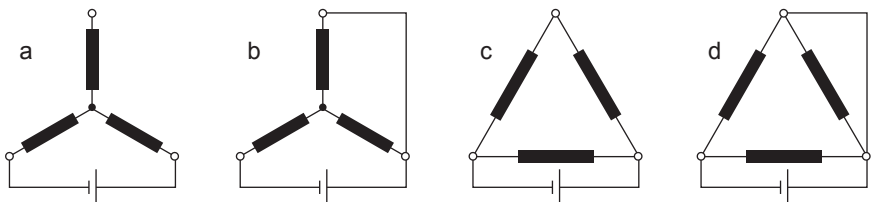

Motor winding connections for D.C. voltage

Operation Braking

The braking current is calculated using the formula:

$$I_f = k1_i \times I_d \sqrt{\frac{C_f - C_{fe}}{k2 - C_d}}$$

The values of k1 for each of the four connections are:

$$\begin{aligned} k1_a &= 1.225 & k1_c &= 2.12 \\ k1_b &= 1.41 & k1_d &= 2.45 \end{aligned}$$

The braking torque can be found by:

$$C_f = \frac{\pi \cdot J \cdot N}{30 \cdot T_f}$$

formulae where:

- If (in A) = direct current for braking
- Id (in A) = starting current during the phase
= $\frac{1}{\sqrt{3}}$ Id as per catalog
(for Δ connection)
- Cf (in N.m) = average braking torque during the time
(Ns , N)
- Cfe (in N.m) = external braking torque
- Cd (in N.m) = starting torque
- J (in kgm²) = total moment of inertia on the motor shaft
- N (in rpm) = speed of rotation
- Tf (in s) = braking time
- k1i = numerical factors for connections a, b, c and d (see diagram)
- k2 = numerical factors taking into account the average braking torque
(k2 = 1.7)

The D.C. voltage to be applied to the windings is calculated by:

$$U_f = k3_i \cdot k4 \cdot I_f \cdot R1$$

k3 values for the four diagrams are as follows:

$$\begin{aligned} k3_a &= 2 & k3_b &= 1.5 \\ k3_c &= 0.66 & k3_d &= 0.5 \end{aligned}$$

- Uf (in V) = D.C. voltage for braking
- If (in A) = direct current for braking
- R1 (in Ω) = stator phase resistance at 20°C
- k3i = numerical factors for diagrams a, b, c and d
- k4 = numerical factor taking account of the temperature rise in the motor (k4 = 1.3)

MECHANICAL BRAKING

Electromechanical brakes (D.C. or A.C. field excitation) can be fitted at the non-drive end of the motor.

For further details, please consult Leroy-Somer.

Operation

Use with Variable Speed Drive

MOTORS USED WITH VARIABLE SPEED DRIVE

GENERAL

Drive control by a frequency inverter can in fact result in an increase in the machine temperature rise, due to a significantly lower supply voltage than on the A.C. supply, additional losses related to the wave form produced by the drive (PWM).

Standard IEC 60034-17 describes numerous good practices for all types of electric motor, however since this is Leroy-Somer's area of specialist expertise, we describe the best ways to deal with variable speed in the section below.

LC motors are particularly suitable for use at constant torque across the entire speed range from 0 to 50 Hz, without derating. The motor cooling capacity remains constant whatever the point of operation.

These motors are quieter when operating at overspeed (above the motor rated speed).

DERATING THE POWER WHEN THE LC RANGE IS USED AT VARIABLE SPEED

The thermal reserve, a Leroy-Somer special feature, should be used to keep the motor in its temperature class. However in certain cases, the temperature class will change from B to F, i.e. between 80 k and 105 k.

ADAPTATION OF MOTORS

A motor is always characterized by the following parameters, which depend on the design:

- temperature class
- voltage range
- frequency range
- thermal reserve

CHANGES IN MOTOR PERFORMANCE

When power is supplied by a drive, changes are observed in the above parameters due to certain phenomena:

- voltage drops in the drive components
- current increase in proportion with the decrease in voltage
- difference in motor power supply according to the type of control (flux vector or U/F)

The main consequence is an increase in the motor current resulting in increased copper losses and therefore a higher temperature rise in the winding (even at 50 Hz).

Above the synchronous speed, the iron losses increase and hence cause further temperature rise in the motor.

The type of control mode influences temperature rise in the motor:

- A U/F ratio gives the fundamental voltage maximum at 50 Hz but requires more current at low speed to obtain a high starting torque and therefore generates a temperature rise at low speed when the motor is poorly ventilated.

- Flux vector control requires less current at low speed while providing significant torque but regulates the voltage at 50 Hz and causes a voltage drop at the motor terminals, therefore requiring more current at the same power.

Consequences on the motor

Reminder: Leroy-Somer recommends the connection of PTC sensors, monitored by the drive, to protect the motor as much as possible.

CONSEQUENCES OF POWER SUPPLIED BY DRIVES

When power is supplied to the motor by a variable speed drive with diode rectifier, this causes a voltage drop (~5%).

Some PWM techniques can be used to limit this voltage drop (~2%), to the detriment of the machine temperature rise (injection of harmonics of orders 5 and 7).

The non-sinusoidal signal (PWM) provided by the drive generates voltage peaks at the winding terminals due to the significant voltage variations related to switching of the IGBTs (also called dV/dt). Repeated overvoltages can eventually damage the windings depending on their value and/or the motor design.

The value of the voltage peaks is proportional to the supply voltage. This value can exceed the minimum voltage for the windings which is related to the wire grade, the impregnation type and the insulation that may or may not be present in the slot bottoms or between phases.

Another option for attaining high voltage values is when regeneration phenomena occur in the case of a driving load, hence the need to prioritize freewheel stops or following the longest permissible ramp.

Operation Use with Variable Speed Drive

INSULATION SYSTEM FOR VARIABLE SPEED APPLICATIONS

The insulation system for the LC series means it can be used on a 2-quadrant drive without modification, regardless of the size of the machine or the application, at a supply voltage ≤ 400 V 50/60 Hz and can tolerate voltage peaks up to 1500 V and variations of 3500 V/ μ s at the motor terminals.

These values are guaranteed without using a filter at the motor terminals.

For any voltage > 400 V, Leroy-Somer's reinforced insulation system (RIS) must be used, unless otherwise agreed by Leroy Somer or a sine filter is used (only compatible with U/f control mode).

RECOMMENDATIONS CONCERNING THE MECHANISM OF ROTATION FOR VARIABLE SPEED APPLICATIONS

The voltage wave form at the drive output (PWM) can generate high-frequency leakage currents that can, in certain situations, damage the motor bearings.

This phenomenon is amplified with:

- High A.C. supply voltages
- Increased motor size
- Incorrectly earthed motor and drive package
- Long cable length between the drive and the motor
- Motor incorrectly aligned with the driven machine

Leroy-Somer machines that have been earthed in accordance with good practice need no special options except in the situations listed below.

- For voltages > 400 V/50/60 Hz, we recommend using an NDE insulated bearing and a DE ground ring.
- Use with a 4-quadrant drive operating in always requires:
 - 1 NDE insulated bearing + 1 DE insulating ring
 - The winding's reinforced insulation system

SUMMARY OF RECOMMENDED PROTECTION DEVICES

Drive power supply type	Stress level experienced by the motor (with cable length ≤ 100 m)
Drive and sine wave filter	1: standard level
2-quadrant drive	2: severe level
4-quadrant drive/Regen	3: extreme level

Note on the order		Leroy-Somer recommendations for motor protection				
Voltage	Stress level	Winding protection	DE insulated bearing	NDE insulated bearing	DE ground ring	Insulated encoder
$U_n \leq 400$ V	1 or 2	standard	no	no	no	no
	3	Adapted RIS*	no	yes	yes	yes
$400V < U_n \leq 500$ V	1	standard	no	yes	yes for $U_n \geq 440$ V	yes
	2	Adapted RIS*	no	yes	yes for $U_n \geq 440$ V	yes
	3	Adapted RIS*	no	yes	yes	yes
500 V $< U_n \leq 690$ V	1	Adapted RIS*	no	yes	yes	yes
	2	Adapted RIS*	no	yes	yes	yes
	3**	Adapted RIS*	no	yes	yes	yes

* RIS: Reinforced Insulation System for the winding. The technical solution is adapted to suit the stress level.

Standard insulation: 1500 V peak and 3500 V/ μ s.

For cable lengths > 100 m, please consult Leroy-Somer.

In the event of a special request for 2 insulated bearings, the ground ring is mandatory.

** For $500V < U_n \leq 690V$ and for stress level 3, the using of reinforced insulation system (SIR), can modify the sizing of the motor.

Operation Use with Variable Speed Drive

GOOD WIRING PRACTICE

It is the responsibility of the user and/or the installer to connect the motor-drive system in accordance with the current legislation and regulations in the country of use. This is particularly important as concerns cable size and connection of earths and grounds.

The following information is given for guidance only, and should never be used as a substitute for the current standards, nor does it relieve the installation company of their responsibility.

To ensure the safety of motors with frame size 315 mm or above, we recommend installing grounding strips between the terminal box and the housing and/or the motor and the driven machine.

For high-powered motors, unshielded single-core power supply cables can be used as long as they are installed together in a metal cable duct earthed on both sides with a grounding strip.

Cables must be kept as short as possible.

Connection of control and encoder cables



Strip back the shielding on the metal clamp collars in order to ensure 360° contact.

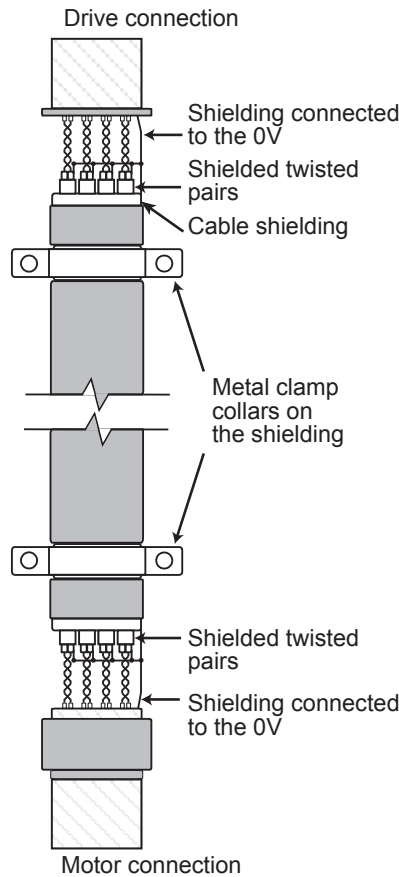

Power cables

The following information is given for guidance only, and should never be used as a substitute for the current standards, nor does it relieve the installation company of their responsibility. For more information, please refer to technical specification IEC 60034-25.

To ensure the safety of personnel, the size of the earthing cables should be determined individually in accordance with local regulations.

For compliance with standard EN 61800-3, the power conductors between drive and motor must be shielded. Use a special variable speed cable: shielded with low stray capacity and with 3 protective earth (PE) conductors arranged at 120° (diagram below). There is no need to shield the drive power supply cables.

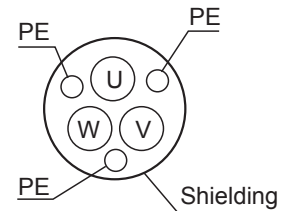

CAUTION: The configuration below is only acceptable if the motor cables incorporate phase conductors with a cross-section less than 10 mm² (motors < 30 kW/40 HP).

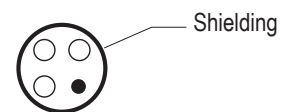

Use of shielded single-core cables is prohibited.

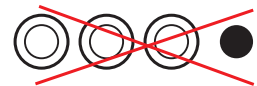

The motor and drive wiring must be symmetrical (U,V,W at the motor end must correspond to U,V,W at the drive end) with the cable shielding grounded at both the drive end and motor end over 360°.

Operation Use with Variable Speed Drive

When the installation complies with emissions standard EMC 61800-3 category C2 (if an HV/LV transformer belongs to the user), the shielded motor power supply cable can be replaced with a 3-core + earth cable placed in a fully-enclosed metal conduit (metal cable duct for example). This metal conduit must be mechanically connected to the electrical cabinet and the structure supporting the motor.

If the conduit consists of several pieces, these must be interconnected by braids to ensure ground continuity.

The cables must be fixed securely at the bottom of the conduit.

The motor earth terminal (PE) must be connected directly to the drive earth terminal.

A separate protective earth (PE) conductor is mandatory if the conductivity of the cable shielding is less than 50% of the conductivity of the phase conductor.

OPERATION AT SPEEDS HIGHER THAN THOSE ASSIGNED BY THE A.C. SUPPLY FREQUENCIES

Using induction motors at high speeds (speed higher than 3600 rpm) can be risky:

- The cage may be damaged
- Bearing life may be impaired
- There may be increased vibration
- etc.

When high-speed motors are used, they often need to be adapted, and an in-depth **mechanical and electrical design exercise is needed.**

ENCODER

As an option, LC motors can be fitted with an incremental or absolute encoder, isolated against any leakage currents generated by operation on a drive.

The encoder is fitted with its protective cover, as shown in the picture below.

Different types of encoder are available according to the application's need for optimal regulation.

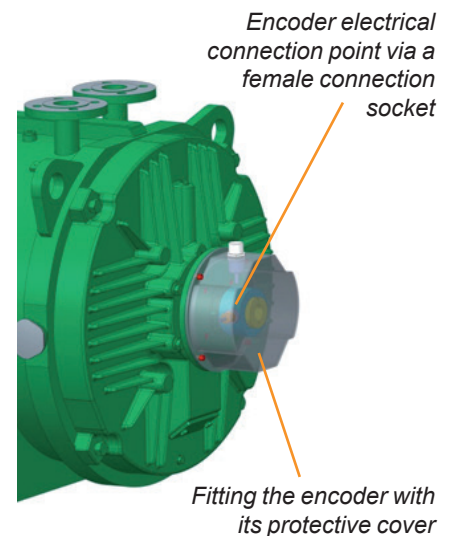

Operation Use with Variable Speed Drive

TYPICAL MOTOR AND DRIVE PACKAGE INSTALLATION

The following information is given for guidance only, and should never be used as a substitute for the current standards, nor does it relieve the installation company of their responsibility.

Depending on the installation, more optional elements can be added to the installation:

Switch-fuse: A padlockable breaking device must be installed to isolate the installation if operator intervention becomes necessary.

This device must provide protection against overheating and short-circuits. The fuse rating is stated in the drive documentation. The switch-fuse can be replaced with a circuit-breaker (with appropriate breaking capacity).

RFI filter: Its role is to reduce the drive electromagnetic emissions, and thus comply with EMC standards. Our drives are, as standard, equipped with an internal RFI filter. Some environments require the addition of an external filter. Please consult the drive documentation to find out the drive conformance levels, with and without an external RFI filter.

Drive power supply cables: These cables do not necessarily need shielding. Their cross-section is recommended in the drive documentation, however, it can be adapted according to the type of cable, installation method, the cable length (voltage drop), etc.

Line reactance: Its role is to reduce the risk of damage to drives following phase imbalance or significant disturbance on the A.C. supply. The line reactance can also reduce low-frequency harmonics.

Motor reactance: different types of reactance or filter are available. The motor reactance can, depending on the circumstances, reduce high-frequency earth leakage currents, residual currents between phases, dV/dt voltage peaks, etc. The choice of reactance depends on the distance between motor and drive.

Motor power supply cables: These cables must be shielded to ensure EMC conformance of the installation. The cable shielding must be connected over 360° at both ends. The cable cross-section is recommended in the drive documentation, however, it can be adapted according to the type of cable, installation method, the cable length (voltage drop), etc.

Encoder cables: The sensor cable shielding is important due to interference with the power cables. This cable must be laid at least 30 cm away from any power cables.

Sizing the power cables: The drive and motor power supply cables must be sized according to the applicable standard, and according to the design current stated in the drive documentation. The different factors to be taken into account are:

- The installation method: in a conduit, a cable tray, suspended, etc.
- The type of conductor: copper or aluminum

Once the cable cross-section has been determined, check the voltage drop at the motor terminals. A significant voltage drop results in increased current and additional losses in the motor (temperature rise).

Equipotential bonding between the frame, motor, drive and ground carried out in accordance with good practice will significantly help reduce the voltage on the shaft and the motor casing, resulting in fewer high-frequency leakage currents. Premature breakage of bearings and auxiliary equipment such as encoders should also be avoided wherever possible.

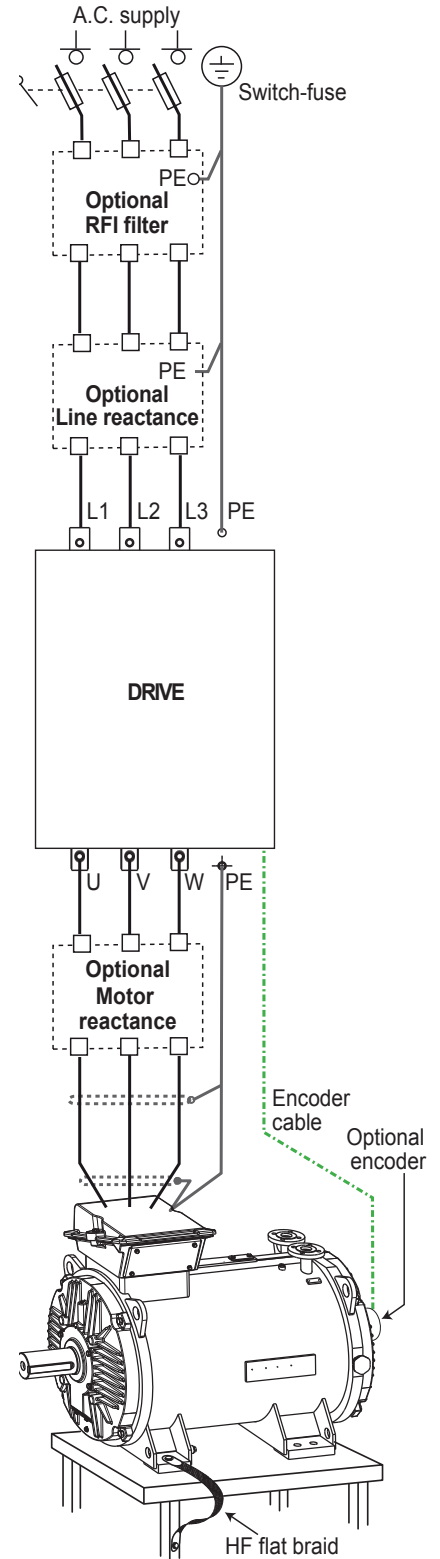

Operation Use with Variable Speed Drive

EXTREME OPERATING CONDITIONS AND OTHER POINTS

MOTOR CONNECTIONS

Leroy-Somer does not recommend any particular connection for applications operating with a single motor on a single drive.

TRANSIENT OVERLOADS

Drives are designed to withstand transient overload peaks of 180% or overloads of 150% for 60 seconds (maximum once every ten minutes). If the overload is greater, the system will automatically shut down. Leroy-Somer motors are designed to withstand these overloads, however in the event of very repetitive operation we still recommend use of a temperature sensor at the heart of the motor.

STARTING TORQUE AND CURRENT

Thanks to advances in control electronics, the torque available when the motor is switched on can be adjusted to a value between the rated torque and the motor and drive breakdown torque. The starting current will be directly related to the torque (120 or 180%).

ADJUSTING THE SWITCHING FREQUENCY

The variable speed drive switching frequency has an impact on losses in the motor and the drive, on the acoustic noise and the torque ripple.

A low switching frequency has an adverse effect on temperature rise in motors.

Leroy-Somer recommends a drive switching frequency of 3 kHz minimum.

In addition, a high switching frequency optimizes the acoustic noise and torque ripple level.

CHOICE OF MOTOR

There are two possibilities:

a - The frequency inverter is not supplied by Leroy-Somer

All the motors in this catalog can be used with a frequency inverter. Depending on the application, motors will need to be derated by around 10% compared to the motor operating curves in order to guarantee that motors will not be damaged.

b - The frequency inverter is supplied by Leroy-Somer

As the motor and drive have been specifically designed for use in combination, excellent performance is guaranteed, in accordance with the curves on the next page.



Operation Use with Variable Speed Drive

APPLICATIONS AND CHOICE OF SOLUTIONS

In principle, there are three typical types of load. It is essential to determine the speed range and the application torque (or power) in order to select the drive system:

CENTRIFUGAL MACHINES

The torque varies as the square of the speed (or cube of the power). The torque required for acceleration is low (about 20% of rated torque). The starting torque is low.

- Sizing: depends on the power or torque at maximum speed.
- Drive selected for normal duty

Typical applications: ventilation, pumping, etc.

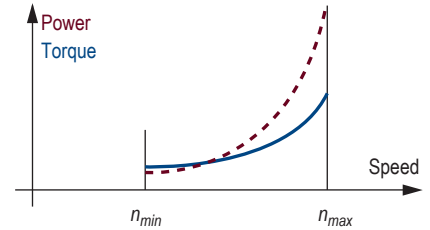

CONSTANT TORQUE APPLICATIONS

The torque remains constant throughout the speed range. The torque required for acceleration may be high, depending on the machine (higher than the rated torque).

- Sizing: depends on the torque required over the entire speed range.
- Drive selected for heavy duty.

Typical machines: extruding machines, grinders, traveling cranes, presses, etc.

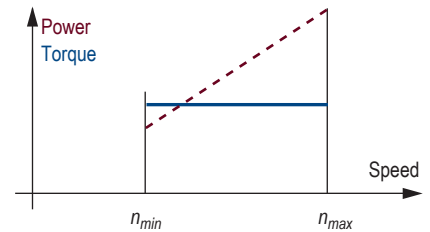

APPLICATIONS WITH CONSTANT POWER

The torque decreases as the speed increases. The torque required for acceleration is no more than the rated torque. The starting torque is at its maximum.

- Sizing: depends on the torque required at minimum speed and the range of operating speeds.
- Drive selected for heavy duty
- An encoder feedback is advisable for improved regulation

Typical machines: winders, machine tool spindles, etc.

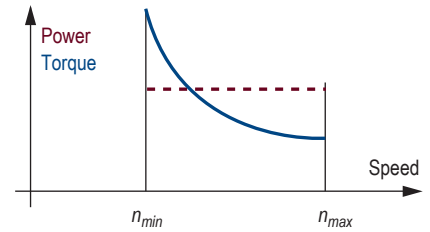

4-QUADRANT MACHINES

These applications have a torque/speed operating type as described opposite, but the load becomes a driving load in certain stages of the cycle.

- Sizing: see above depending on the load.
- In the case of repetitive braking, install a reinforced insulation system (RIS).
- Drive selected: to dissipate the power from a driving load, it is possible to use a braking resistor, or to send power back to the grid. In the latter case, a regenerative or 4-quadrant drive should be used.

Typical machines: centrifuges, traveling cranes, presses, machine tool spindles, etc.

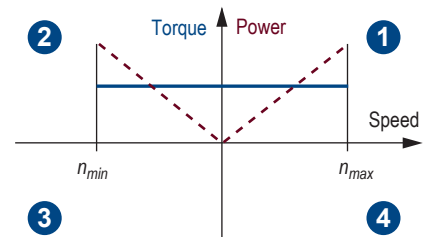

Operation Operation as an Asynchronous Generator

GENERAL

The motor operates as an asynchronous generator each time the load becomes a driving load and the rotor speed exceeds the synchronous speed (N_s).

This can be induced either voluntarily, as in the case of electric power plants (water or wind power, etc.) or involuntarily, caused by factors linked to the application (downward movement of crane hooks or blocks, inclined conveyors, etc.).

OPERATING CHARACTERISTICS

The diagram opposite shows the various operations of an asynchronous machine in relation to its slip (g) or its speed (N).

For example: let us consider an LC 315 LB induction motor of 250 kW, 4 poles, 50 Hz at 400 V. As a rough estimate, its characteristics as an asynchronous generator can be deduced from its rated characteristics as a motor, by applying the rules of symmetry.

If more precise values are required, the manufacturer should be consulted.

In practice, it can be checked that the same machine, operating as a motor and as a generator with the same slip, has approximately the same losses in both cases, and therefore virtually the same efficiency. It can be deduced from this that the rated electrical power supplied by the asynchronous generator will be virtually the same as the motor output power.

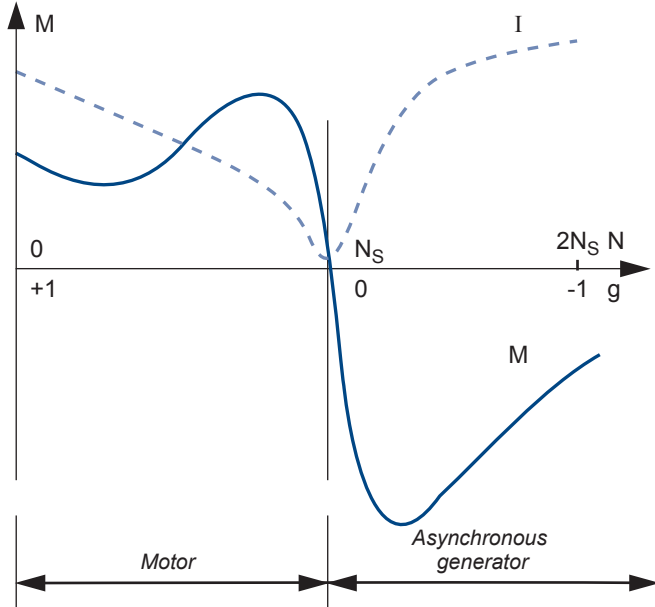

Characteristic	Motor	AG
Synchronous speed (rpm)	1500	1500
Rated speed (rpm)	1484	1516
Rated torque (m.N)	+ 1613	- 1613
Rated current at 400 (A)	440 A (absorbed)	440 A (supplied)

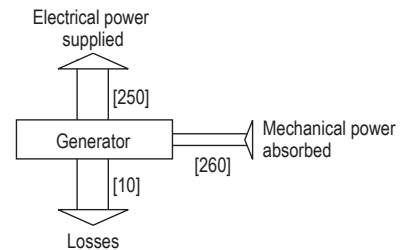
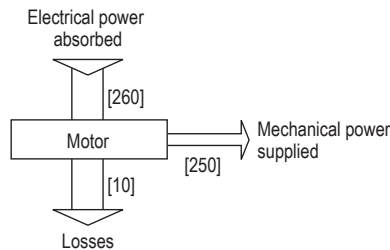
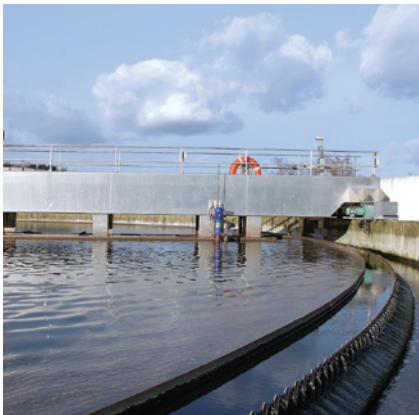

Operation Operation as an Asynchronous Generator

CONNECTION TO A POWERFUL MAINS SUPPLY

It is assumed that the machine stator is connected to a powerful electrical A.C. supply (usually the national grid), i.e. a supply provided by an alternator that regulates the power to at least twice that of the asynchronous generator.

Under these conditions, the A.C. supply imposes its own voltage and frequency on the asynchronous generator. Furthermore, it automatically supplies it with the reactive energy necessary for all its operating conditions.

CONNECTION - DISCONNECTION

Before connecting the asynchronous generator to the grid, it is necessary to ensure that the direction of phase rotation of the asynchronous generator and the grid are in the same order.

- To connect an asynchronous generator to the grid, it should be accelerated gradually until it reaches its synchronous speed N_s . At this speed, the machine torque is zero and the current is minimal.

This is an important advantage of asynchronous generators: as the rotor is not polarized until the stator is powered on, it is not necessary to synchronize the A.C. supply and the machine when they are connected.

However, there is a phenomenon affecting the connection of asynchronous generators which, in some cases, can be a nuisance: the asynchronous generator rotor, although not energized, still has some residual magnetism.

On connection, when the magnetic fluxes created by the A.C. supply and that caused by the rotor residual magnetism are not in phase, the stator experiences a very brief current peak (one or two half-waves), combined with an instantaneous overtorque of the same duration.

It is advisable to use connecting stator resistances to limit this phenomenon.

- Disconnecting the asynchronous generator from the grid does not pose any particular problem.

As soon as the machine is disconnected, it becomes electrically inert since it is no longer energized by the grid. It no longer brakes the driving machine, which should therefore be stopped to avoid reaching overspeed.

Reactive power compensation

To limit the current in the lines and the transformer, the asynchronous generator can be compensated by restoring the power factor of the installation to the unit, using a bank of capacitors.

In this case, the capacitors are only inserted at the terminals of the asynchronous generator once it has been connected, to avoid self-energization of the machine due to the residual magnetism during speed pick-up. For a three-phase low voltage asynchronous generator, three-phase or single-phase capacitors in delta connection are used.

Electrical protection and safety

There are two protection and safety categories:

- those which relate to the grid
- those which relate to the set and its generator

The major grid protection devices monitor:

- maximum-minimum voltage
- maximum-minimum frequency
- minimum power or energy feedback (operating as a motor)
- generator connection fault

The protection devices for the set are:

- stop on detection of racing start
- lubrication faults
- thermal-magnetic protection of the generator, usually with probes in the winding

POWER SUPPLY FOR AN ISOLATED NETWORK

This concerns supplying a consuming network that does not have another generator of sufficient power to impose its voltage and frequency on the asynchronous generator.

REACTIVE POWER COMPENSATION

In the most common case, reactive energy must be supplied:

- to the asynchronous generator
- to the user loads which consume it

To supply both of these consumption types with reactive energy, a reactive energy source of suitable power is connected in parallel on the circuit. This is usually a bank of capacitors with one or more stages which can be fixed, manually adjusted (using notches) or automatically adjusted. Synchronous capacitors are now rarely used.

Example: In an isolated network with power consumption of 50 kW where $\cos \varphi = 0,9$ (and $\tan \varphi = 0.49$), supplied by an asynchronous generator with $\cos \varphi$ of 0.8 at 50 kW (and $\tan \varphi = 0.75$), it is necessary to use a bank of capacitors which supplies: $(50 \times 0.49) + (50 \times 0.75) = 62$ kvar.



Operation Special Environments

Some industries and processes are particularly harsh for electric motors.

In order to meet the needs of harsh operating applications, Leroy-Somer, thanks to its long experience of different applications and feedback from users and service centers, has developed solutions adapted to cope with difficult operating conditions.

MERCHANT NAVY APPLICATIONS

ONBOARD INDUSTRIAL APPLICATIONS

- air compressors
- refrigeration compressors
- pumps
- fans
- conveyors



Constraint: salt corrosion, heavy-duty use, operational safety, conformance with specifications of classification bodies according to use.

Solution: motors providing any type of electrical and mechanical protection according to need.



BUREAU
VERITAS



DNV

Motors for "Marine" applications Comply with the specifications of the IACS classification bodies (LR, RINA, BV, DNV, ABS, etc.): high ambient temperature, overload, increased tolerance to rated voltage and frequency, overspeed, etc.).

ELECTRIC PROPULSION

- main propulsion
- auxiliary propulsion (bow thrust propulsion)



Constraint: reduced weight and dimensions, silent operation, high specific output power, low starting current, high efficiency, conformance with specifications of classification bodies according to use.

Solution: IP23 air-cooled motors, air-cooled motors with air/water exchangers, LC motors with double-walled water-cooled housings. Magnetic circuits suitable for a high number of starts/hour.

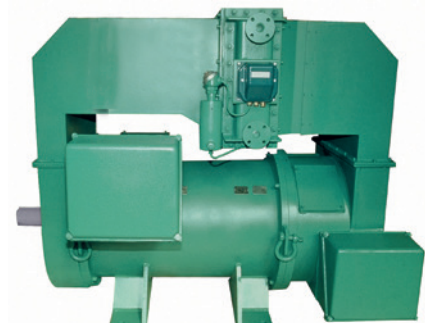

Technical Characteristics Designation

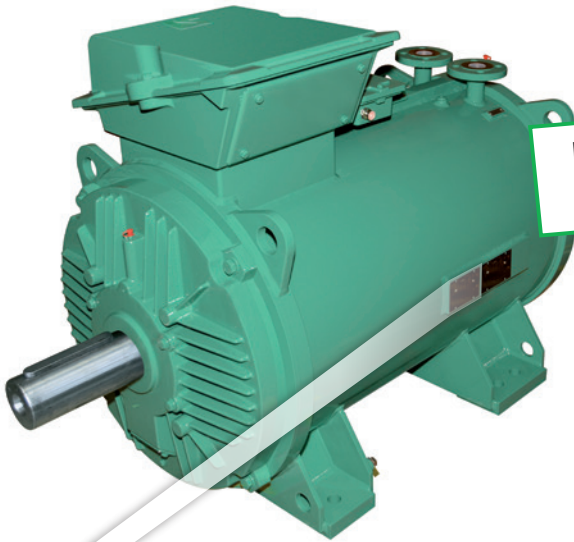

IP 55
Cl. F - ΔT 80 K

The complete motor **reference** described below will enable you **to order** the desired equipment.

The selection method consists of following the terms in the designation.

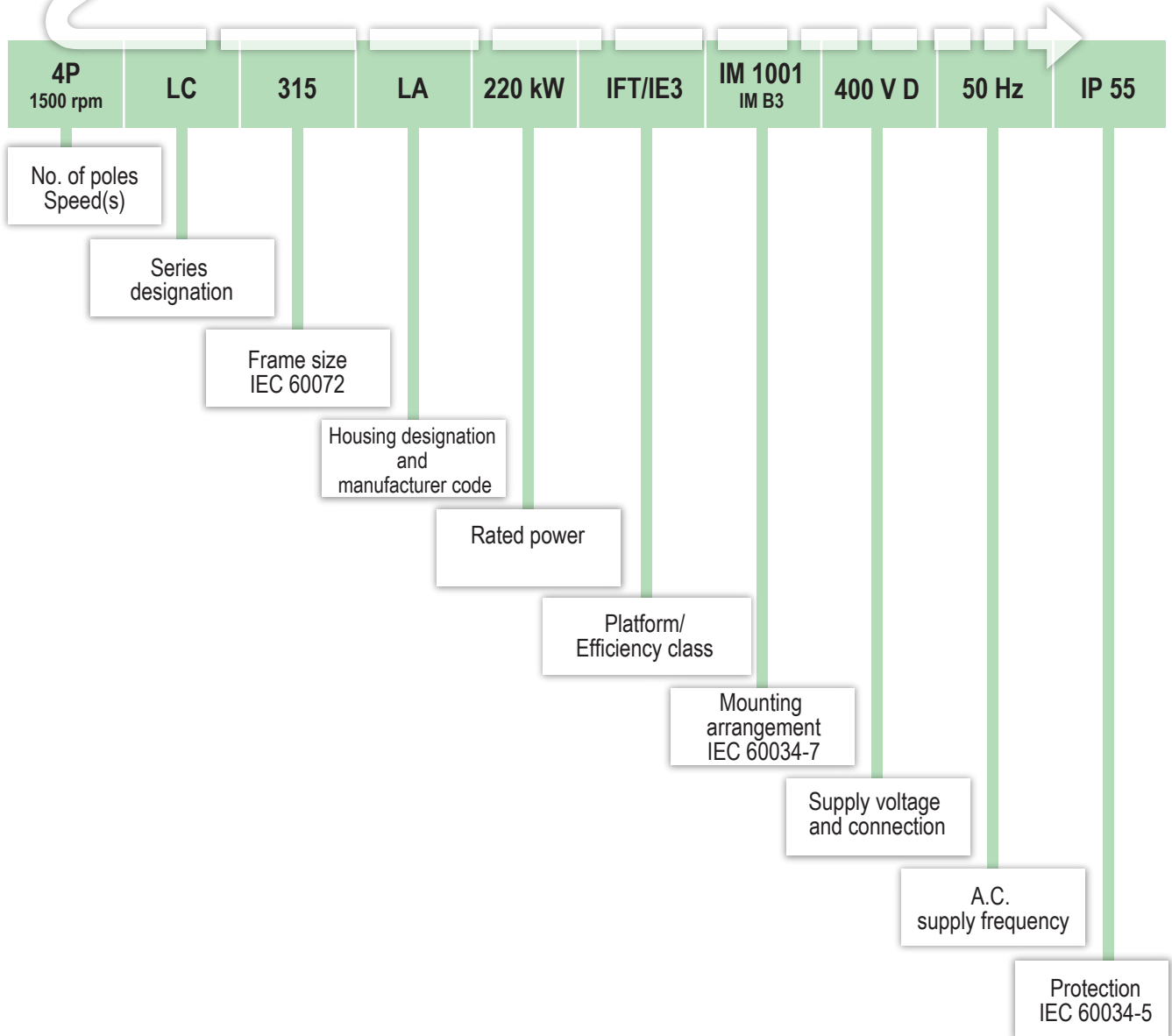

Technical Characteristics Identification

NAMEPLATES

The nameplate is used to identify motors, state the main performance levels and demonstrate compatibility of the relevant motor with the main international standards and regulations that concern it.

All the motors in this catalog have two nameplates: one dedicated to performance when the motor is powered on the A.C. supply and the other dedicated to performance when the motor is powered on a drive.

The table below explains the various markings.

		Nameplate marking	CE	cURus	cCSAus	IEC & CE (IE3)	CSAE	ee (CC055B)	NEMA Premium
LC motors liquid-cooled IP55	Power ≥ 150 kW	2, 4 & 6 P	Standard	Option	-	Standard	-	-	-

Option: may be available to order. In certain cases this option may involve modification or special sizing of the motor.

DEFINITION OF SYMBOLS USED ON NAMEPLATES



A.C. power supply nameplate

MOT 3 ~ : three-phase A.C. motor
LC : series
450 : frame size
LA : housing symbol
4 : number of poles

IP55 IK08 : ingress protection
Ins cl. F : Insulation class F
40°C : ambient operating temperature
S1 : Duty - Operating factor
kg : weight
V : supply voltage
Hz : supply frequency
rpm : revolutions per minute
kW : rated power
cos φ : power factor
A : rated current
Δ : delta connection
Y : star connection

Min Water Flow (l/min) : minimum water flow
Max Water Temp (°C) : max. water inlet temperature
Max pressure (bars) : maximum pressure

Bearings

DE : drive end bearing
NDE : non drive end bearing
g : amount of grease at each regreasing (in g)
h : regreasing interval (in hours)

POLYREX EM103 : type of grease

A : vibration level

H : balancing mode

Please quote when ordering spare parts

Drive power supply nameplate:

Inverter settings : values needed to set the frequency inverter
Motor performance : available torque on the motor shaft expressed as a % of the rated torque at the stated frequencies
Min. Fsw (kHz) : minimum acceptable switching frequency for the motor
Nmax (rpm) : maximum mechanical speed acceptable for the motor

Technical Characteristics
Identification

IE3 LIQUID-COOLED LC MOTOR NAMEPLATES

Leroy-Somer		MOT. 3~ LC 450 LA 4				CE	
N° 74893200XM01		2016	4100 kg				
DE 6326 C3	80 g	3000 h	IP 55	1000 m			
NDE 6324 C3	72 g	3700 h	IK 08	IM 1001		IE3	
40 °C	Ins cl. F	S 1	100%	6 d/h	SF 1.0	97.4 %	
V	Hz	min ⁻¹	kW	A	cos φ	%	
Δ 400	50	1491	1000	1665	0.89	97.4	
Δ 690	50	1491	1000	961	0.89		
Δ 380	50	1490	1000	1739	0.90		
Δ 415	50	1492	1000	1623	0.88		
Δ 460	60	1788	1000	1448	0.89	97.4	
Moteurs Leroy-Somer Bd Marcelin Leroy CS10015 16915 Angoulême cedex 9 - France Polyrex EM 103 Min water flow = 70 l/min Max water temp = 38°C Max pressure = 5 bars IEC 60034-1 - MADE IN FRANCE							

Leroy-Somer		MOT. 3~ LC 450 LA 4				CE	
N° 74893200XM01		2016	4100 kg				
DE 6326 C3	80 g	3000 h	IP 55	1000 m			
NDE 6324 C3	72 g	3700 h	IK 08	IM 1001		IE3	
40 °C	Ins cl. F	S 9	%	d/h	SF		
Inverter settings							
V	Hz	min ⁻¹	kW	A	cos φ		
Δ 400	50	1491	1000	1800	0.89	min. Fsw (kHz) : 3	
Nmax (min ⁻¹) : 2610							
Motor performance							
Hz	10	17	25	50	60	87	
T/Tn%	100	100	100	100	83	57	
Polyrex EM 103 Min water flow = 70 l/min Max water temp = 38°C Max pressure = 5 bars IEC 60034-1 - MADE IN FRANCE							

European regulations require motors offered for sale on the market to be IE3 or IE2 + drive from 1 January 2015.

The motors in this catalog conform to regulation 640/2009 (and its various amendments) in the ErP directive.

For better selection, use and adjustment of the drive parameters, IE3 motors, as defined in the following pages, have dual nameplates so as to obtain equally good performance on an A.C. supply (non-EU market) and on a drive (EU market).

* Values on the nameplate given for information only.

Technical Characteristics

Description of an LC Motor basic conception

Description	Materials	Comments
Housing	Steel	With lifting rings Double wall for circulation of water. Ground terminals
Stator	Insulated low-carbon FeSi magnetic steel laminations Electroplated copper	Fully-processed magnetic steel laminations Welded packs Semi-enclosed slots Class F insulation
Rotor	Insulated low-carbon FeSi + Aluminum or copper alloy magnetic steel laminations, depending on the version	Inclined cage bars Rotor cage pressure die-cast in aluminum or soldered in copper Shrink-fitted to shaft, or keyed for soldered rotors
Shaft	Steel	Overhanging key
End shields	Steel or cast iron	Water-cooled in some cases
Bearings and lubrication	-	Regreasable ball bearings
Grease	Polyrex EM103	-
Labyrinth seals Lipseal	-	Decompression grooves
Nameplate	Stainless steel	2 nameplates: 1 with values for operation on A.C. supply 1 with values for operation on drive
Screws	Stainless steel	-
Terminal box A.C. supply connection	Steel or cast iron	Can be turned round Drill holes and cable gland only available as options Ground terminal or bar For frame sizes ≤ 355 : 1 terminal block with 6 steel terminals as standard For frame sizes ≥ 355 LK and ≤ 500 : 2 terminal blocks with 6 steel terminals as standard
Auxiliary terminal box	Cast iron	1 terminal box with 2 ISO16 drill holes for connecting: - the water leak detector - any space heaters
Balancing method	-	Half-key balancing for vibration class level A as standard
Ingress protection	-	IP55, other protection levels (IP56 or IP65) on request
Cooling index	-	IC 71 W

Technical Characteristics

Cooling Method

Designation for the IC (International Cooling) coded cooling method in the IEC 60034-6 standard.

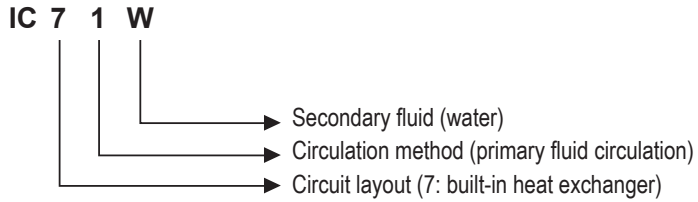

Circuit layout

Characteristic number	Abbreviated description	Description
7 ⁽¹⁾	Built-in heat exchanger (not using the surrounding environment)	The primary coolant (air) circulates in a closed circuit, transferring its heat to a secondary coolant (water) - which is not the one round the machine - in an integral heat exchanger inside the machine.

⁽¹⁾ The nature of the heat exchanger elements is not specified (smooth or finned tubes, corrugated surfaces, etc.)

Circulation method (primary fluid circulation)

Characteristic number	Abbreviated description	Description
1	Self-circulating	Circulation of the coolant depends on the rotational speed of the main machine, and is caused by the action of the rotor alone, or a device mounted directly on it.

Coolant (secondary coolant)

Characteristic letter	Type of fluid
W	Water

The water inlet and outlet flanges (secondary circuit) are located on top of the housing as standard. Other positions can be considered on request.

Legend plates indicate the water circuit inlet and outlet.

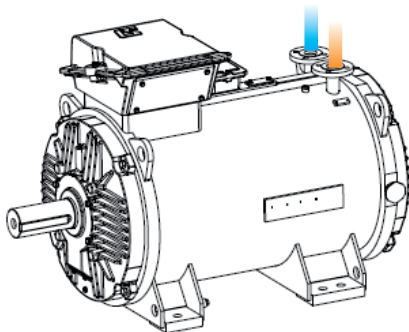

LC 315 to LC 355 L

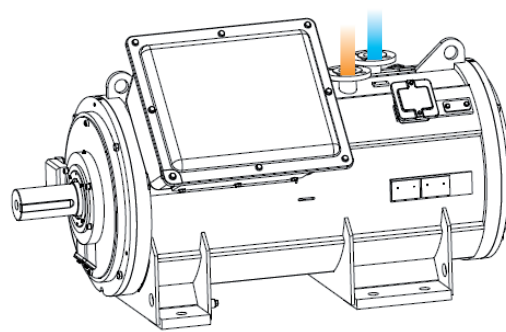

LC 355 LK to LC 500

Technical Characteristics

Cooling Method

1 - Leroy-Somer's LC motors are designed with IE3 efficiency level up to a water inlet temperature of 38°C max. If you require efficiency classes with different water inlet temperatures, please consult Leroy-Somer.

2 - Water quality: the motor water circuit has the following properties:

The motor housings consist of a double-walled steel body in which the water circulates.

Precautions concerning the industrial cooling water must be taken in accordance with good practice, in particular avoiding build-up of scale, corrosion and proliferation of organic matter. The typical values below are given for guidance only:

- pH from 7.5 to 8.5
- CaCO₃: 100 to 400 mg/l
- Cl⁻: < 200 mg/l

• Conductivity: 1000 to 1500 µS/cm
Do not operate the motor without cooling water.

3 - The motors in this catalog are defined for the following operating conditions:
Ambient temperature: -16°C to +40°C
Altitude ≤ 1000 m. For use at an ambient temperature below +5°C, glycol-type antifreeze must be added to the cooling water in proportions of 40% antifreeze/60% water.

4 - Impact of the water inlet temperature on the design:

With the standard design, the water inlet temperature is:

• 32°C for LC 315 to LC 355 motors. For temperatures between 32°C < T° < 38°C, depending on the number of poles and power rating, the motor design can be adapted.

• 38°C for LC 355 LK to LC 500 motors. For temperatures T° > 38°C, please consult Leroy-Somer.

Frame size	Minimum flow (liter/min)	Max. pressure drop (bar)	Max. pressure (bar)	Max. water temperature rise (°C)
315	30	1	5	5
315LK/355	30	1	5	6
355 LK 2 poles	50	1	5	6
355 LK 4-6 poles	40	1	5	6
400	45	1	5	6
400 LK/450	70	1	5	6
500 L 4 poles	100	1	5	6
500 M 6 poles	80	1	5	6

Important: it is vital that you inform us of the water inlet temperature on the order

5 - Water circuit drain hole and degassing valves:

LC motors are fitted as standard with water circuit drain holes and degassing valves.

LC 315 L to LC 355 L

Degassing
3/8"

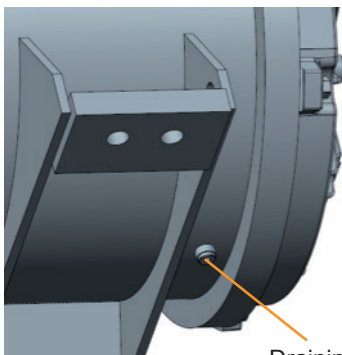
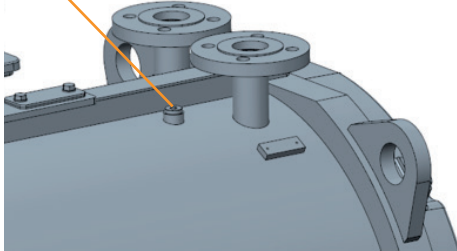

Draining 3/8"

LC 355 LK to LC 500

Degassing
LC 355 LK to LC 450 = 3/8"
LC 500 = 1/2"

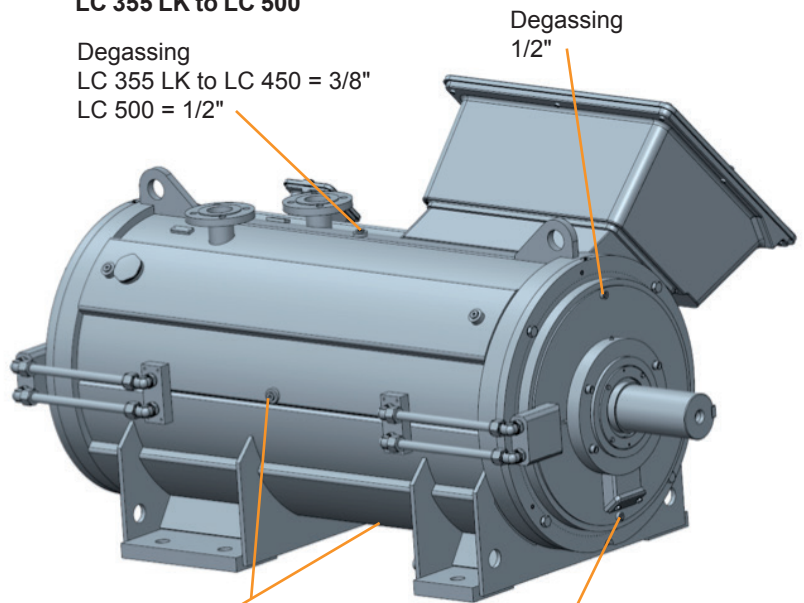

Draining
LC 355 LK to LC 450 = 3/8"
LC 500 = 1/2"

Degassing
1/2"

Draining
1/2"

Technical Characteristics Standard Equipment

PLUG WITH BREATHABLE MEMBRANE

The motors in this catalog are supplied as standard with an integral breathable waterproof membrane. This PTFE membrane is air- and steam-permeable but liquid-proof (IP66 min.).

The coolant circulates around the motor, subjecting it to significant temperature variations. Depending on the environmental conditions, condensation therefore sometimes forms in the motor. There may be a lot of these condensates, and they can damage the motor. The usual solution consists of getting rid of them by means of the drain holes at the bottom of the motor.

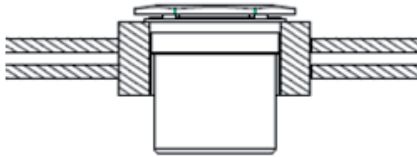

These drain holes are also present, but thanks to the presence of this plug with breathable membrane on LC motors, not many maintenance operations are needed.

This system is patented by Leroy-Somer.

LC 315 and LC 355 L

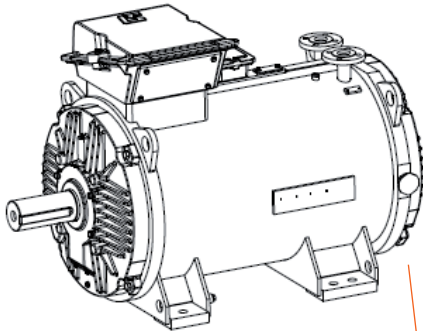

Plug with breathable membrane

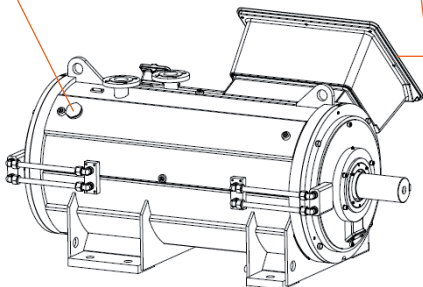

LC 355LK, LC 400, LC 450 and LC 500

WATER LEAK DETECTOR

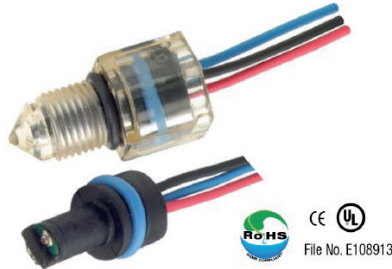

A leak detector is fitted on each motor as standard. Regardless of the motor configuration (horizontal or vertical) the detector is fitted on the bottom.

The detector uses optical technology. The sensor consists of an infrared emitter and an optical receiver. The receiver is thus able to detect the presence of water due to a change in the way light is transmitted from the emitter.

Its characteristics are as follows:

Voltage	12V ±10%
Current	40 mA max.
Output type	Open in case of default
Temperature	-40°C / +110°C

An external power supply must be provided.

This is connected in the auxiliary terminal box provided as standard.

ELECTRICAL CONNECTIONS

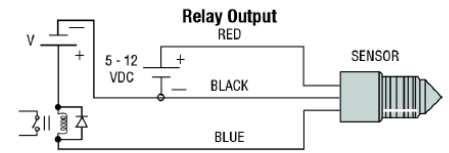
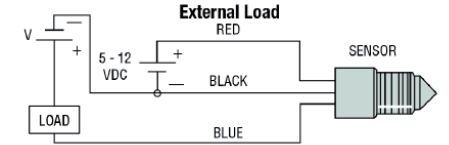

The water leak detector is located inside the motor on the DE shield.

Technical Characteristics

Optional Features

OPERATION ON A DRIVE

- Reinforced winding insulation (Leroy-Somer's RIS system)
- Insulated ball bearing, DE and/or NDE
- DE ground ring
- Insulated encoder with its protective cover

MECHANICAL ADAPTATION

- Terminal box on the left or right as seen from the drive end
- Roller bearings
- 2nd shaft extension
- DE shaft:
 - differs from the catalog
 - tapered (10% amount of taper)
 - smooth without key
 - special key

- Enlarged main terminal box for LC 315, LC 315 LK & LC 355 L that can accommodate 2 terminal blocks.

IMPORTANT: In this case only 1 auxiliary terminal box is possible, and orientation of the cable entries will be limited to left and right (180°).

- Balancing:
 - class B
 - F (full key) or N (no key)
- Preparation for SPM probes:
 - DE and NDE: 12 hrs - 12 hrs
 - DE: 3 hrs – 9 hrs – 12 hrs and NDE: 3 hrs – 9 hrs – 12 hrs – axial

MOTOR PROTECTION

- IP56 or IP65 protection
- Thermal sensors in the windings and endshields (PT100, PTC, KTY, PTO or PTF, thermocouples, etc.)
- Space heaters
- Class H winding insulation
- 2nd auxiliary terminal box (without encoder), with 2 ISO 20 drill holes for connecting the thermal protection
- Terminal box equipment for Drive application.
Set including :
 - earth straps (frame housing/ terminal body, terminal body/terminal cover, terminal cover/terminal box spacer).
 - one earth bar inside terminal box.
 - and one terminal box spacer.This set is standard for LC 500 motors.

- Corrobloc finition (External finish syst IIIa, brass cable gland)
- brass cable gland
- Full tropicalization
- Non-magnetic cable gland support plate

MISCELLANEOUS

- Conformance with cURus (for the winding insulation system)
- Other paint shades

We are also able to offer on request other features such as:

- Power ratings/frame sizes:
 - < LC 315
 - > LC 500
- Special fittings for the water inlet and outlet
- Brake

Technical Characteristics Handling

LIFTING THE MOTOR ONLY (not coupled to the machine)

The regulations stipulate that over 25 kg, suitable handling equipment must be used.

All our motors are fitted with grab handles, making them easier to handle without risk. A diagram of the lifting ring position appears below with the required dimensions.

To prevent any damage to the motor during handling (for example: switching the motor from horizontal to vertical), it is essential to follow these instructions.

POSITION OF LIFTING RINGS

Type	La	Lb	Lc	Ld
LC 315	950	490	475	670
LC 355	1050	560	540	760
LC 355 LK/LC 400	1220	-	-	630
LC 400 LK/LC 450	1410	-	-	730
LC 500 M	1720	-	-	840
LC 500 L	2020	-	-	840

LC 315 and LC 355

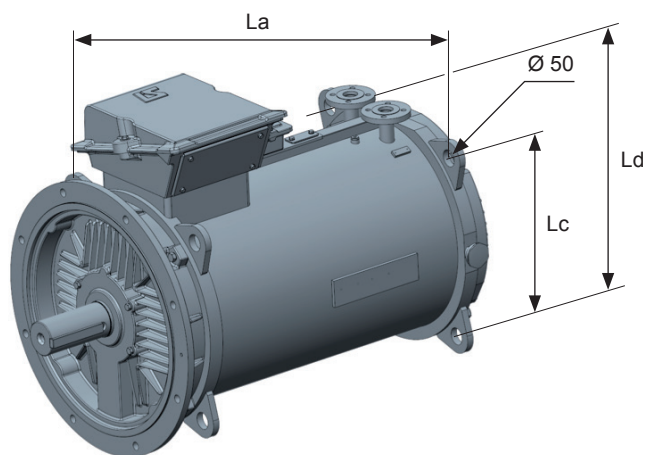
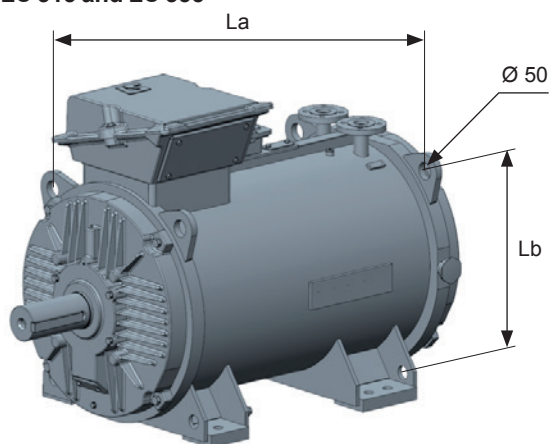

LC 355 LK to LC 500

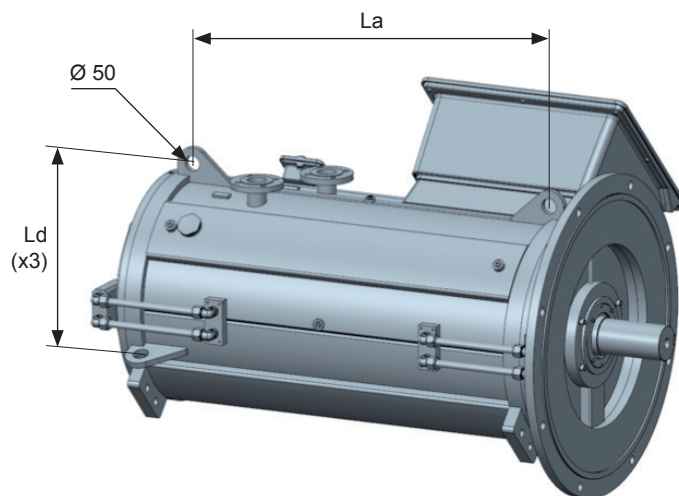
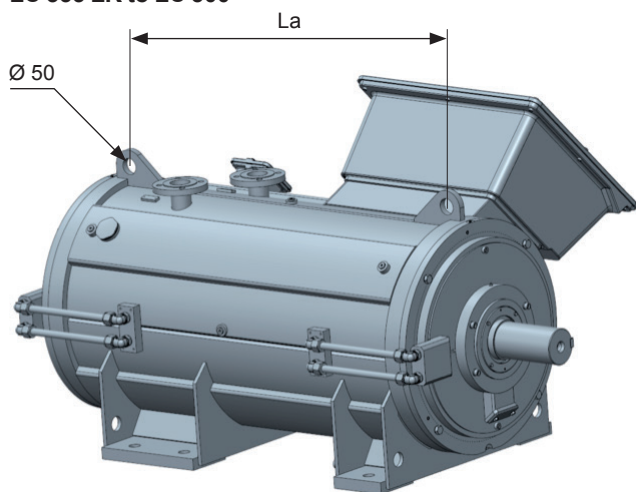

Electrical Characteristics IE3 Mains Supply

The efficiency values indicated in the table below are minimum values

2-POLES

Type	Rated power	Rated torque	Starting torque/ Rated torque	Maximum torque/ Rated torque	Starting current/ Rated current	Moment of inertia	Weight	Noise (50 Hz)	400 V/50 Hz							
									Rated speed	Rated current	Efficiency IEC 60034-2-1 - 2007			Power factor		
	P_n kW	M_n N.m	M_d/M_n	M_m/M_n	I_d/I_n	J kg.m ²	IM B3 kg	LP db(A)			N_n rpm	I_n A	4/4	η 3/4	2/4	4/4
LC 315 LA	220	707	1.9	2.6	6.3	1.5	1101	60	2970	366	96.4	96.6	96.4	0.90	0.88	0.84
LC 315 LB	250	802	2.4	2.9	7.6	1.6	1118	60	2976	422	96.4	96.6	96.4	0.88	0.86	0.82
LC 315 LKA	315	1008	2.7	3.0	8.0	3.7	1656	66	2984	538	96.4	96.4	96.2	0.87	0.85	0.81
LC 315 LKB	355	1136	2.7	3.0	8.0	3.7	1656	66	2981	606	96.4	96.4	96.2	0.87	0.85	0.81
LC 315 LKC	400	1281	3.0	2.4	7.6	3.7	1656	66	2980	682	96.4	96.5	96.3	0.87	0.86	0.82
LC 355 LA	400	1281	3.0	2.4	7.6	3.7	1681	66	2980	682	96.4	96.5	96.3	0.87	0.86	0.82
LC 355 LB	450	1440	1.6	2.5	5.7	4.5	1746	66	2984	753	96.4	96.4	96.2	0.89	0.88	0.85
LC 355 LKA	550	1763	1.8	2.4	6.2	4.1	2253	70	2980	908	96.4	96.4	96.2	0.90	0.89	0.86
LC 355 LKB	700	2243	2.1	2.6	6.8	4.5	2487	70	2980	1152	96.4	96.5	96.2	0.90	0.89	0.86

4-POLES

Type	Rated power	Rated torque	Starting torque/ Rated torque	Maximum torque/ Rated torque	Starting current/ Rated current	Moment of inertia	Weight	Noise (50 Hz)	400 V/50 Hz							
									Rated speed	Rated current	Efficiency IEC 60034-2-1 - 2007			Power factor		
	P_n kW	M_n N.m	M_d/M_n	M_m/M_n	I_d/I_n	J kg.m ²	IM B3 kg	LP db(A)			N_n rpm	I_n A	4/4	η 3/4	2/4	4/4
LC 315 LA	220	1420	2.6	3.0	6.3	3.1	1170	60	1485	380	96.5	96.9	97.0	0.87	0.84	0.75
LC 315 LB	250	1608	2.4	2.1	6.4	3.2	1200	60	1485	441	96.3	96.7	96.8	0.86	0.83	0.75
LC 315 LKA	315	2022	2.2	2.8	7.3	5.9	1552	66	1488	536	96.5	96.5	96.1	0.88	0.85	0.77
LC 315 LKB	355	2279	2.4	2.6	7.6	6.3	1606	66	1488	618	96.4	96.4	96.0	0.86	0.83	0.75
LC 315 LKC	400	2568	2.4	3.4	7.5	7.0	1688	66	1488	706	96.6	96.9	96.8	0.85	0.82	0.75
LC 355 LA	400	2568	2.4	3.4	7.5	7.0	1716	66	1488	706	96.6	96.9	96.8	0.85	0.82	0.75
LC 355 LB	450	2879	1.6	3.1	8.0	9.3	1852	66	1493	770	96.6	96.9	96.9	0.87	0.85	0.79
LC 355 LC	500	3204	1.6	2.8	8.1	9.3	1912	66	1490	849	96.6	96.9	97.1	0.88	0.86	0.80
LC 355 LKA	560	3602	0.8	2.3	5.6	11.4	2405	70	1485	955	96.1	96.4	96.4	0.88	0.86	0.81
LC 355 LKB	630	4054	0.8	2.3	5.6	12.1	2519	70	1484	1075	96.1	96.4	96.4	0.88	0.87	0.82
LC 400 LA	750	4797	1.2	2.9	8.5	16.6	2847	70	1493	1256	96.6	96.9	96.9	0.89	0.86	0.79
LC 400 LKA	850	5442	1.0	2.9	8.2	32.8	4066	70	1492	1398	96.6	96.9	96.9	0.90	0.89	0.85
LC 450 LA	1000	6402	1.1	3.0	8.9	32.8	4098	70	1492	1661	96.6	96.9	96.9	0.89	0.88	0.84
LC 450 LB	1200	7687	1.0	2.8	7.4	32.8	4098	70	1491	2026	96.6	96.9	96.9	0.88	0.87	0.83
LC 500 L	1500	9607	0.3	1.9	5.1	67.2	6300	80	1491	2529	96.2	96.3	96.0	0.89	0.88	0.87

6-POLES

Type	Rated power	Rated torque	Starting torque/ Rated torque	Maximum torque/ Rated torque	Starting current/ Rated current	Moment of inertia	Weight	Noise (50 Hz)	400 V/50 Hz							
									Rated speed	Rated current	Efficiency IEC 60034-2-1 - 2007			Power factor		
	P_n kW	M_n N.m	M_d/M_n	M_m/M_n	I_d/I_n	J kg.m ²	IM B3 kg	LP db(A)			N_n rpm	I_n A	4/4	η 3/4	2/4	4/4
LC 315 LA	150	1447	2.7	2.1	6.1	3.9	1157	60	990	277	95.7	95.9	95.6	0.82	0.78	0.69
LC 315 LB	170	1645	1.8	2.6	6.8	4.2	1214	60	987	304	95.6	95.8	95.5	0.84	0.80	0.71
LC 315 LKA	270	2597	2.0	2.8	7.1	10.6	1692	65	993	483	96.3	96.3	95.6	0.84	0.80	0.69
LC 315 LKB	315	3021	5.5	3.9	9.7	12.3	1783	65	996	557	96.5	96.5	95.8	0.84	0.80	0.70
LC 355 LA	270	2597	2.0	2.8	7.1	10.6	1720	65	993	483	96.3	96.3	95.6	0.84	0.80	0.69
LC 355 LB	315	3021	5.5	3.9	9.7	12.3	1811	65	996	557	96.5	96.5	95.8	0.84	0.80	0.70
LC 355 LKA	355	3418	1.8	2.7	7.1	14.8	2292	66	992	640	96.3	96.4	96.0	0.83	0.79	0.69
LC 355 LKB	400	3863	1.3	2.4	5.3	14.8	2319	66	989	718	96.5	96.9	96.9	0.84	0.80	0.71
LC 355 LKC	500	4830	1.3	2.0	5.3	16.3	2459	66	989	886	95.9	96.1	95.7	0.85	0.81	0.73
LC 400 LA	500	4830	1.3	2.0	5.3	16.3	2504	66	989	886	95.9	96.1	95.7	0.85	0.81	0.73
LC 400 LB	600	5774	1.74	2.5	6.4	19	2830	66	992	1108	96.5	96.9	96.9	0.81	0.77	0.67
LC 400 LKA	850	8175	1.1	2.9	7.6	44.4	3818	72	993	1447	96.5	96.8	96.8	0.87	0.84	0.77
LC 450 LA	950	9153	1.2	2.9	7.8	48.3	4106	72	993	1614	96.5	96.8	96.7	0.88	0.85	0.78
LC 450 LB	1050	10120	1.1	2.9	7.0	48.3	4106	72	992	1768	96.5	96.8	96.8	0.89	0.86	0.79
LC 500M**	1300	12475	0.9	2.4	6.4	83.2	6280	80	995	1401	96.5	96.6	96.4	0.80	0.76	0.67

** 690 V 50 Hz values - Motor optimized at variable speed for voltage 690 V D 50 Hz. Please consult Leroy-Somer for other values

Electrical Characteristics IE3 Mains Supply

The efficiency values indicated in the table below are minimum values

2-POLES

Type	Rated power	380 V/50 Hz				415 V/50 Hz				460 V/60 Hz				
		Rated speed	Rated current	Efficiency	Power factor	Rated speed	Rated current	Efficiency	Power factor	Rated power	Rated speed	Rated current	Efficiency	Power factor
	P_n kW	N_n rpm	I_n A	η 4/4	$\cos \phi$ 4/4	N_n rpm	I_n A	η 4/4	$\cos \phi$ 4/4	P_n kW	N_n rpm	I_n A	η 4/4	$\cos \phi$ 4/4
LC 315 LA	220	2966	385	96.5	0.90	2973	353	97.0	0.89	220	3574	316	97.2	0.90
LC 315 LB	250	2973	440	96.8	0.89	2978	413	97.1	0.87	250	3579	365	97.3	0.88
LC 315 LKA	315	2982	562	97.3	0.88	2985	523	97.3	0.86	315	3585	467	97.4	0.87
LC 315 LKB	355	2978	634	97.2	0.87	2982	586	97.3	0.87	355	3583	524	97.4	0.87
LC 315 LKC	400	2977	715	96.8	0.88	2982	662	97.3	0.86	400	3583	588	97.3	0.88
LC 355 LA	400	2977	715	96.8	0.88	2982	662	97.3	0.86	400	3583	588	97.3	0.88
LC 355 LB	450	2982	795	97.3	0.88	2986	727	97.6	0.88	450	3583	650	97.5	0.89
LC 355 LKA	550	2976	958	96.8	0.90	2982	877	97.2	0.90	550	3583	787	97.4	0.90
LC 355 LKB	700	2978	1216	97.2	0.90	2982	1109	97.6	0.90	700	3582	999	97.7	0.89

4 POLES

Type	Rated power	380 V/50 Hz				415 V/50 Hz				460 V/60 Hz				
		Rated speed	Rated current	Efficiency	Power factor	Rated speed	Rated current	Efficiency	Power factor	Rated power	Rated speed	Rated current	Efficiency	Power factor
	P_n kW	N_n rpm	I_n A	η 4/4	$\cos \phi$ 4/4	N_n rpm	I_n A	η 4/4	$\cos \phi$ 4/4	P_n kW	N_n rpm	I_n A	η 4/4	$\cos \phi$ 4/4
LC 315 LA	220	1482	396	96.3	0.88	1486	371	96.7	0.85	220	1786	329	97.0	0.86
LC 315 LB	250	1481	459	96.0	0.87	1484	430	96.2	0.84	250	1788	380	97.2	0.85
LC 315 LKA	315	1486	557	96.3	0.89	1489	527	96.7	0.86	315	1789	461	96.9	0.89
LC 315 LKB	355	1486	636	96.2	0.88	1489	612	96.5	0.84	355	1789	530	96.7	0.87
LC 315 LKC	400	1486	722	96.4	0.87	1489	703	96.7	0.82	400	1789	603	96.9	0.86
LC 355 LA	400	1486	722	96.4	0.87	1489	703	96.7	0.82	400	1789	603	96.9	0.86
LC 355 LB	450	1492	782	96.9	0.90	1493	733	97.2	0.88	450	1793	662	97.4	0.88
LC 355 LC	500	1489	877	96.8	0.89	1491	837	97.2	0.86	500	1791	730	97.3	0.88
LC 355 LKA	560	1482	998	95.8	0.89	1486	932	96.3	0.87	560	1787	823	96.6	0.88
LC 355 LKB	630	1481	1126	95.8	0.89	1486	1046	96.3	0.87	630	1786	927	96.6	0.88
LC 400 LA	750	1492	1302	96.9	0.90	1494	1233	97.2	0.87	750	1794	1088	97.3	0.89
LC 400 LKA	850	1491	1472	97.2	0.90	1492	1352	97.5	0.90	850	1792	1215	97.5	0.90
LC 450 LA	1000	1491	1738	97.3	0.90	1492	1618	97.5	0.88	1000	1792	1436	97.5	0.90
LC 450 LB	1200	1490	2125	96.9	0.88	1491	1966	97.3	0.87	1200	1791	1749	97.3	0.88

6-POLES

Type	Rated power	380 V/50 Hz				415 V/50 Hz				460 V/60 Hz				
		Rated speed	Rated current	Efficiency	Power factor	Rated speed	Rated current	Efficiency	Power factor	Rated power	Rated speed	Rated current	Efficiency	Power factor
	P_n kW	N_n rpm	I_n A	η 4/4	$\cos \phi$ 4/4	N_n rpm	I_n A	η 4/4	$\cos \phi$ 4/4	P_n kW	N_n rpm	I_n A	η 4/4	$\cos \phi$ 4/4
LC 315 LA	150	989	289	95.2	0.83	991	272	95.7	0.80	150	1191	239	96.2	0.82
LC 315 LB	170	985	319	95.4	0.85	988	296	95.8	0.83	170	1188	264	96.2	0.84
LC 315 LKA	270	992	493	96.3	0.86	993	482	96.3	0.81	270	1194	417	96.5	0.84
LC 315 LKB	315	995	569	96.8	0.87	996	556	97.0	0.81	315	1196	482	97.2	0.84
LC 355 LA	270	992	493	96.3	0.86	993	482	96.3	0.81	270	1194	417	96.5	0.84
LC 355 LB	315	995	569	96.8	0.87	996	556	97.0	0.81	315	1196	482	97.2	0.84
LC 355 LKA	355	991	662	96.1	0.85	993	630	96.4	0.81	355	1193	554	96.7	0.83
LC 355 LKB	400	987	760	95.3	0.84	990	694	96.1	0.83	400	1191	620	96.5	0.84
LC 355 LKC	500	986	934	95.4	0.85	990	857	96.2	0.84	500	1190	763	96.6	0.85
LC 400 LA	500	986	934	95.4	0.85	990	857	96.2	0.84	500	1190	763	96.6	0.85
LC 400 LB	600	991	1156	96.2	0.82	993	1095	96.5	0.79	600	1194	930	97.0	0.80
LC 400 LKA	850	992	1487	96.8	0.90	993	1430	97.2	0.85	850	1193	1248	97.4	0.88
LC 450 LA	950	992	1657	97.0	0.90	994	1593	97.3	0.85	950	1194	1389	97.4	0.88
LC 450 LB	1050	990	1827	96.7	0.90	993	1740	97.0	0.86	1050	1193	1525	97.5	0.89

Electrical Characteristics
IE3 Variable Speed Drive Supply

2-POLES

Type	400 V/50 Hz				% Rated torque M _n at					Maximum mechanical speed
	Rated power	Rated speed	Rated current	Power factor	10 Hz	17 Hz	25 Hz	50 Hz	87 Hz	
	P _n kW	N _n rpm	I _n A	Cos φ 4/4						
LC 315 LA	220	2970	393	0.90	100	100	100	100	—	3600
LC 315 LB	250	2976	457	0.88	100	100	100	100	—	3600
LC 315 LKA	315	2984	582	0.87	100	100	100	100	—	3600
LC 315 LKB	355	2981	656	0.87	100	100	100	100	—	3600
LC 315 LKC	400	2980	740	0.87	100	100	100	100	—	3600
LC 355 LA	400	2980	740	0.87	100	100	100	100	—	3600
LC 355 LB	450	2984	814	0.89	100	100	100	100	—	3600
LC 355 LKA	550	2980	983	0.90	100	100	100	100	—	3600
LC 355 LKB	700	2980	1252	0.90	100	100	100	100	—	3600

4-POLES

Type	400 V/50 Hz				% Rated torque M _n at					Maximum mechanical speed
	Rated power	Rated speed	Rated current	Power factor	10 Hz	17 Hz	25 Hz	50 Hz	87 Hz	
	P _n kW	N _n rpm	I _n A	Cos φ 4/4						
LC 315 LA	220	1485	406	0.87	100	100	100	100	57	2610
LC 315 LB	250	1484	468	0.86	100	100	100	100	57	2610
LC 315 LKA	315	1488	575	0.88	100	100	100	100	57	2610
LC 315 LKB	355	1488	664	0.86	100	100	100	100	57	2610
LC 315 LKC	400	1488	755	0.85	100	100	100	100	57	2610
LC 355 LA	400	1488	755	0.85	100	100	100	100	57	2610
LC 355 LB	450	1493	830	0.87	100	100	100	100	57	2610
LC 355 LC	500	1490	912	0.88	100	100	100	100	57	2610
LC 355 LKA	560	1485	1027	0.88	100	100	100	100	—	1800
LC 355 LKB	630	1484	1155	0.88	100	100	100	100	—	1800
LC 400 LA	750	1493	1353	0.89	100	100	100	100	—	1800
LC 400 LKA	850	1492	1517	0.90	100	100	100	100	—	1800
LC 450 LA	1000	1492	1804	0.89	100	100	100	100	—	1800
LC 450 LB	1200	1491	2189	0.88	100	100	100	100	—	1800

6-POLES

Type	400 V/50 Hz				% Rated torque M _n at					Maximum mechanical speed
	Rated power	Rated speed	Rated current	Power factor	10 Hz	17 Hz	25 Hz	50 Hz	87 Hz	
	P _n kW	N _n min ⁻¹	I _n A	Cos φ 4/4						
LC 315 LA	150	990	296	0.82	100	100	100	100	57	1740
LC 315 LB	170	987	328	0.84	100	100	100	100	57	1740
LC 315 LKA	270	993	517	0.84	100	100	100	100	57	1740
LC 315 LKB	315	996	602	0.84	100	100	100	100	57	1740
LC 355 LA	270	993	517	0.84	100	100	100	100	57	1740
LC 355 LB	315	996	602	0.84	100	100	100	100	57	1740
LC 355 LKA	355	992	688	0.83	100	100	100	100	57	1740
LC 355 LKB	400	989	765	0.84	100	100	100	100	57	1740
LC 355 LKC	500	989	951	0.85	100	100	100	100	57	1740
LC 400 LA	500	989	951	0.85	100	100	100	100	57	1740
LC 400 LB	600	991	1196	0.82	100	100	100	100	57	1740
LC 400 LKA	850	993	1570	0.87	100	100	100	100	57	1740
LC 450 LA	950	993	1735	0.88	100	100	100	100	57	1740
LC 450 LB	1050	992	1918	0.88	100	100	100	100	57	1740

Electrical Characteristics IE3 Variable Speed Drive Supply

Reminder of recommended protection devices

Drive power supply type	Stress level experienced by the motor (with cable length ≤ 100 m)
Drive and sine wave filter	1: standard level
2-quadrant drive	2: severe level
4-quadrant drive/Regen	3: extreme level

Note on the order		Leroy-Somer recommendations for motor protection				
Voltage	Stress level	Winding protection	DE insulated bearing	NDE insulated bearing	DE ground ring	Insulated encoder
$U_n \leq 400 \text{ V}$	1 or 2	standard	no	no	no	no
	3	Adapted RIS*	no	yes	yes	yes
$400 \text{ V} < U_n \leq 500 \text{ V}$	1	standard	no	yes	yes for $U_n \geq 440 \text{ V}$	yes
	2	Adapted RIS*	no	yes	yes for $U_n \geq 440 \text{ V}$	yes
	3	Adapted RIS*	no	yes	yes	yes
$500 \text{ V} < U_n \leq 690 \text{ V}$	1	Adapted RIS*	no	yes	yes	yes
	2	Adapted RIS*	no	yes	yes	yes
	3**	Adapted RIS*	no	yes	yes	yes

* RIS: Reinforced Insulation System for the winding. The technical solution is adapted to suit the stress level.

Standard insulation: 1500 V peak and 3500 V/ μs .

For cable lengths > 100 m, please consult Leroy-Somer.

In the event of a special request for 2 insulated bearings, the ground ring is mandatory.

** For $500\text{V} < U_n \leq 690\text{V}$ and for stress level 3, the using of reinforced insulation system (SIR), can modify the sizing of the motor.



REMINDER: All 2, 4 and 6-pole motors offered for sale on the EU market must be IE3 or IE2 and used with a variable speed drive:

- from 01/01/2015 for 0.75 to 375 kW ratings
- from 01/01/2017 for 0.75 to 375 kW ratings
- In addition, to be eligible for efficiency class IE3, the water inlet temperature for water-cooled motors must be between 0°C and +32°C.

Electrical Characteristics Terminal Block Connection

TERMINAL BLOCKS

All standard motors are supplied with a wiring diagram in the terminal box.

The connector links required for coupling can be found inside the terminal box.

Tightening torque for the nuts on the terminal blocks

Terminal	M4	M5	M6	M8	M10	M12	M14	M16
Torque N.m	1	2.5	4	10	20	35	50	65

Series	Motor type	Terminals
LC	315 LA/LB/LKA/LKB/LKC	M12
	355 LA/LB/LC	
	355 LKA/LKB	M14
	400 LA/LB/LKA	
	450 LA/LB	
500 M/L	M16	

The usual wiring diagrams are as follows:

LC 315 L, 315 LK and 355 L motors: connection is on 6 terminals.

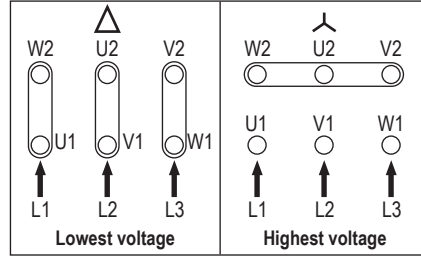

LC 355 LK, 400 L, 400 LK, 450 and 500 motors: connection is on 12 terminals.

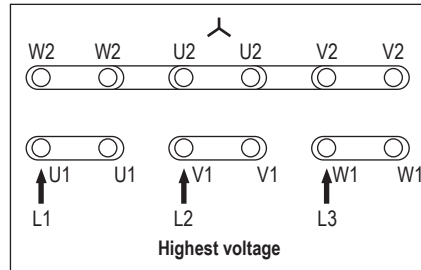
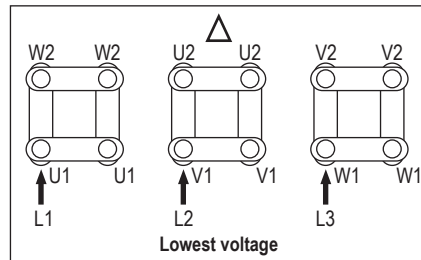

When the motor is supplied with power by a drive, L1, L2 and L3 are replaced by the U, V and W drive connections.

DIRECTION OF ROTATION

The direction of rotation seen from the shaft end is always found by:

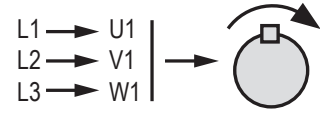



If 2 phases of the power supply are changed over, the motor will rotate anti-clockwise (the motor should be checked first to ensure that it has been designed for both directions of rotation).

If the motor is controlled by a Powerdrive MD2, a function that can be used to reverse the direction of rotation via a parameter is available as standard, thus avoiding the need to modify the wiring.

Mechanical Characteristics Mounting Arrangements

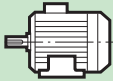
MOUNTINGS AND POSITIONS (IEC 60034-7)

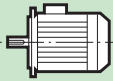
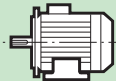
Foot mounted motors		IM 1001 (IM B3) - Horizontal shaft - Feet on floor			IM 1071 (IM B8) - Horizontal shaft - Feet on top		
• all frame sizes							
		IM 1051 (IM B6) - Horizontal shaft - Wall mounted with feet on left when viewed from drive end			IM 1011 (IM V5) - Vertical shaft facing down - Feet on wall		
		IM 1061 (IM B7) - Horizontal shaft - Wall mounted with feet on right when viewed from drive end			IM 1031 (IM V6) - Vertical shaft facing up - Feet on wall		
(FF) flange mounted motors		IM 3001 (IM B5) - Horizontal shaft			IM 2001 (IM B35) - Horizontal shaft - Feet on floor		
• all frame sizes (except IM 3001 limited to frame size 225 mm)							
		IM 3011 (IM V1) - Vertical shaft facing down			IM 2011 (IM V15) - Vertical shaft facing down - Feet on wall		
		IM 3031 (IM V3) - Vertical shaft facing up			IM 2031 (IM V36) - Vertical shaft facing up - Feet on wall		

Frame size (mm)	Mounting positions											
	IM 1001	IM 1051	IM 1061	IM 1071	IM 1011	IM 1031	IM 3001	IM 3011	IM 3031	IM 2001	IM 2011	IM 2031
315 to 450	●	■	■	■	■	■	■	●	■	●	■	■
500	●							●		●		

● : possible positions

■ : please consult Leroy-Somer specifying the coupling method and the axial and radial loads if applicable

Mechanical Characteristics Terminal Box Connection

MAIN TERMINAL BOX

Placed as standard on the top of the motor at the drive end, it is IP 55 protection and fitted with an undrilled removable support plate.

The terminal box of B3 construction LC 315, LC 315 LK and LC 355 motors (except for LK versions) are fitted on top of the motor. As standard the cable outlets are on the right as seen from the drive end, positions on the left and at the drive end are possible as options.

For these frame sizes a larger version of the terminal box is available on request.

The terminal box of LC 355 LK to LC 500 motors are fitted at 45° on the right as seen from the drive end. The cable outlet can be on the bottom as standard or on top as an option. The terminal box position at 45° on the left is available as an option.

Positions of the terminal box in relation to the drive end (motor in IM 1001 position)

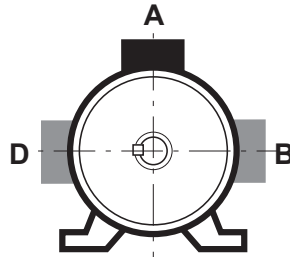

LC 315 to LC 355 motors (except for 355 LK)

A: standard position

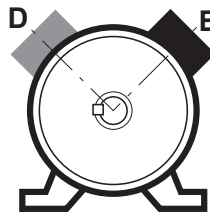

LC 355 LK to LC 500 motors

B: standard position

Terminal box position	A	B	D
LC315, LC315LK and LC355	●	◆	◆
LC355LK, LC400, LC450 and LC500		●	■

● standard ◆ on request ■ as an option

Cable gland positions in relation to the drive end

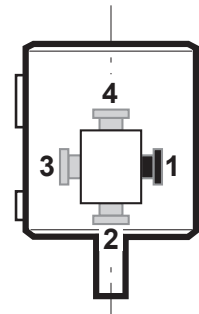

Position 1: standard on delivery (can be turned)

Position 2: not recommended (impossible on standard (FF) flange mounted motors)

Cable gland position	1	2	3	4
LC315, LC315LK and LC355	●	■	■	-
LC355LK, LC400, LC450 and LC500	●	-	■	-

● standard ■ as an option - not possible

DESCRIPTIVE TABLE OF TERMINAL BOXES FOR 400 V RATED SUPPLY VOLTAGE (according to EN 50262)

Series	Type	Terminal box material	Power + auxiliaries	
			Number of drill holes	Drill hole diameter
LC	315	Cast iron	0	Standard: undrilled removable slim mounting plate. As an option: removable thick mounting plate for tapping
	355	Cast iron	0	
	400	Cast iron	0	Standard: thick removable mounting plate for tapping
	450	Cast iron	0	
	500	Steel	0	

AUXILIARY TERMINAL BOXES

An auxiliary terminal box for additional equipment (e.g. water leak detector, space heaters) is available on these motors. It is drilled with two holes with a plug (2 x ISO 16).

A second auxiliary terminal box drilled with two holes with a plug (2 x ISO 20) is available as an option, for connecting thermal protection such as PT100, PTC, etc. .

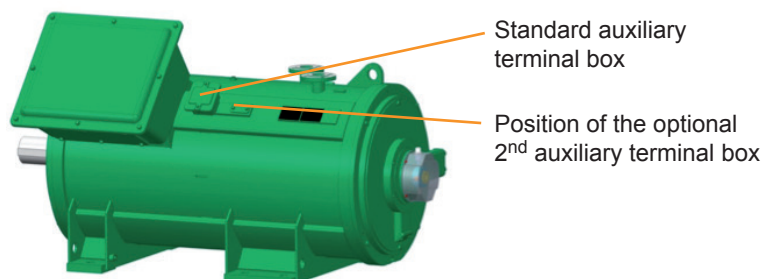

Mechanical Characteristics

Terminal Box Connection

DIMENSIONS OF CABLE GLAND SUPPORT PLATES FOR THE MAIN TERMINAL BOX

Motor type	Diagram	Usable area for drill holes on cable gland mounting plates (dimensions in mm)	
		Without cable spreader (standard)	With cable spreader (as an option*)
LC 315 LA/LB	1	H = 115 L = 125	H = 135 L = 280
LC 315 LKA/LKB/LKC			
LC 355 LA/LB/LC			
LC 355 LKA/LKB/LKC	2	H = 170 L = 460	H = 170 L = 460
LC 400 LA/LB			
LC 400 LKA			
LC 450 LA/LB			
LC 500 M/L	3	-	H = 290 L = 774

* standard for the LC 500 motor

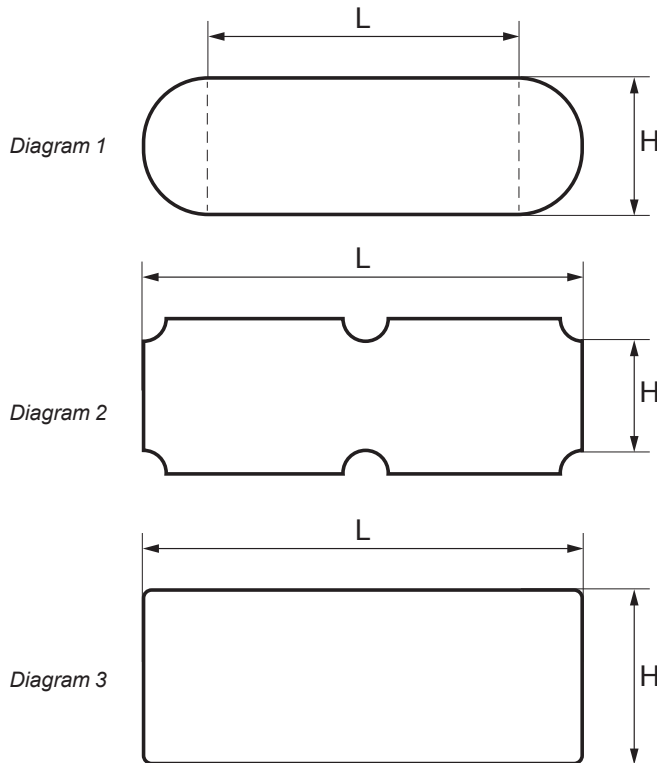

A cable spreader, mounted on the main terminal box, is available as an option.

LC 315 L - 315 LK - 355 L

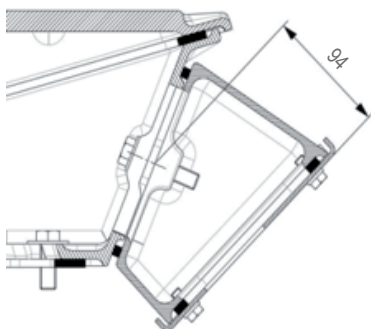

LC 355 LK - 400 L - 400 LK - 450 L

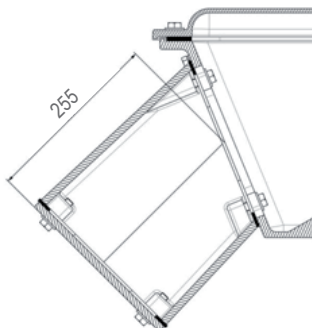

FLYING LEADS

According to specification, motors can be supplied with flying leads using single-core cables (as an option, the cables can be protected by a sheath) or multicore cables.

Please state cable characteristics (cross-section, length, number of conductors), connection method (flying leads or on a terminal block) and the drill hole position.

GROUND TERMINAL OR BAR

The ground terminal is located inside the terminal box. Consisting of a threaded stud with a hexagonal nut, it is used to connect cables with cross-sections at least as large as the cross-section of the phase conductors.

It is indicated by the sign \perp in the terminal box molding.

A ground terminal is also fitted on one of the feet of the frame; a second terminal can be requested as an option.

For Drive application, a grounding bar is systematically fitted inside the terminal box, with earths straps and terminal box spacer, as provided by the option described on page 57 § "Motor Protection".

WIRING DIAGRAMS

All standard motors are supplied with a wiring diagram in the terminal box.

See the "Terminal Block Connection" section for electrical connections.

Mechanical Characteristics Terminal Box Connection

SIZE AND DIMENSIONS OF THE MAIN TERMINAL BOXES

LC 315 L - 315 LK - 355 L

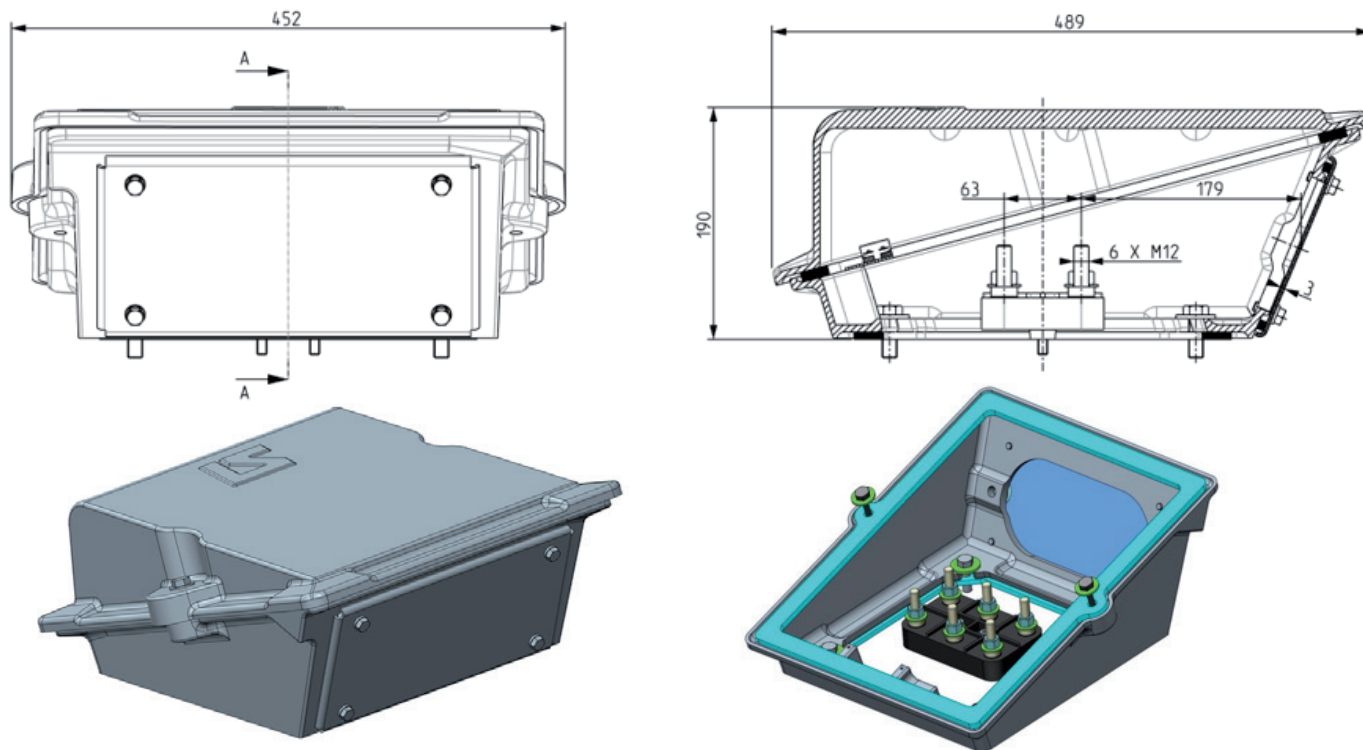

LC 355 LK - 400 L - 400 LK - 450 L

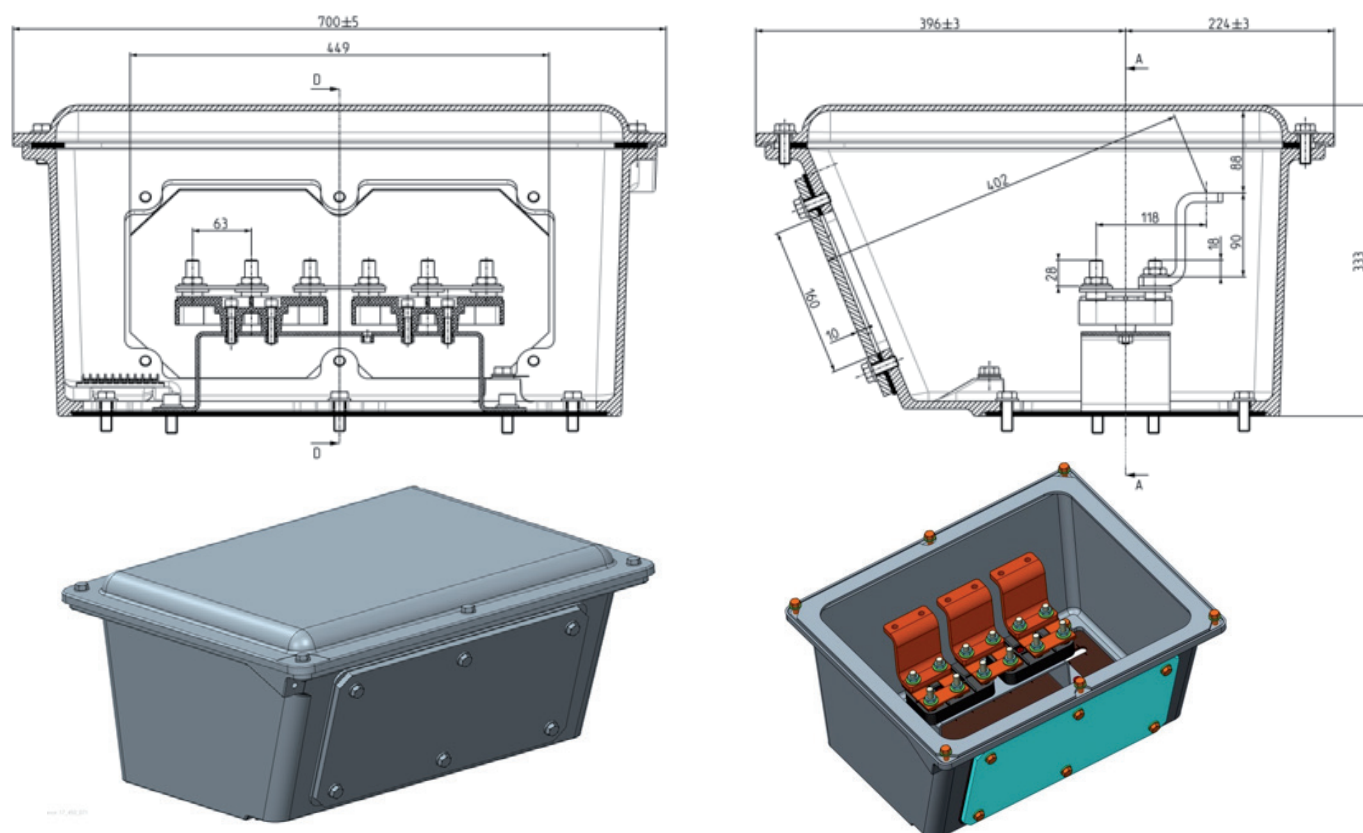

Mechanical Characteristics

Terminal Box Connection

SIZE AND DIMENSIONS OF THE MAIN TERMINAL BOXES

LC 500

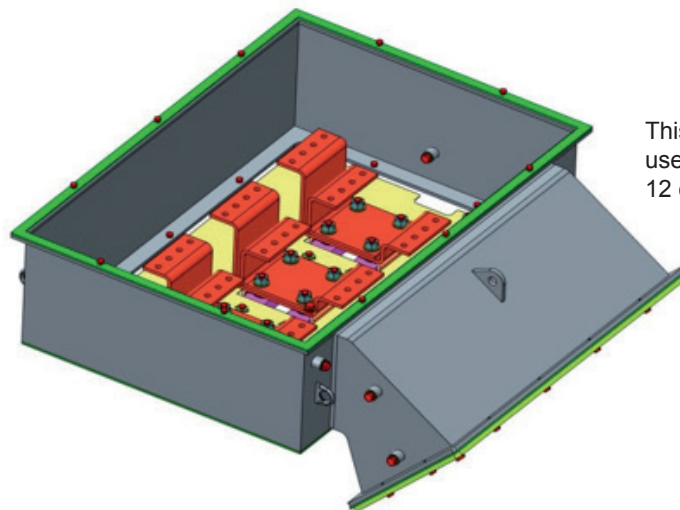
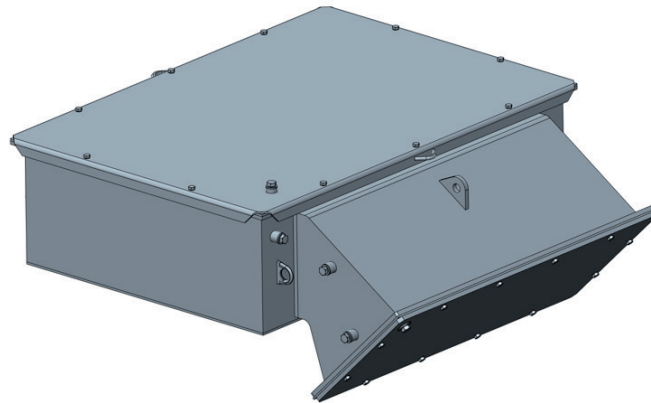
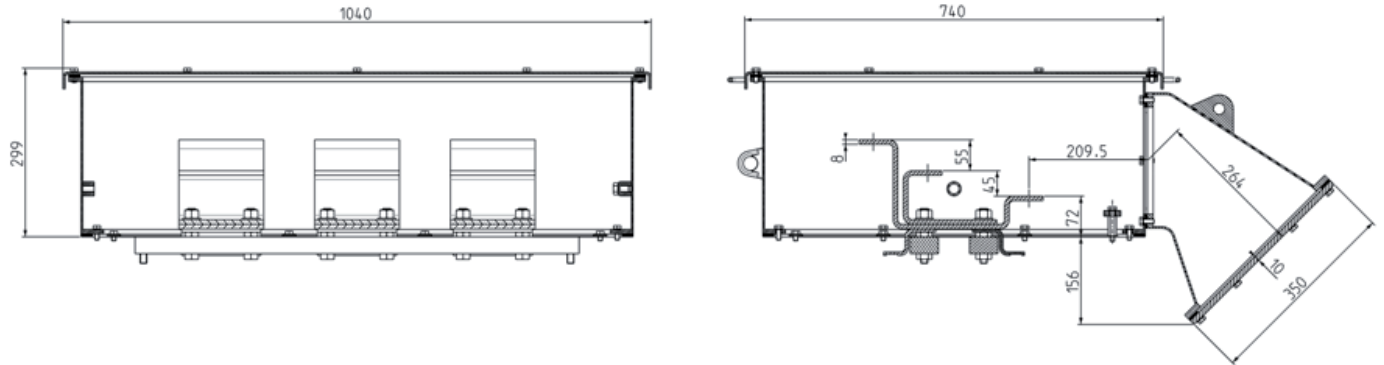

This configuration is used to connect up to 12 conductors per phase

Mechanical Characteristics Shaft End Dimensions

Dimensions in millimeters

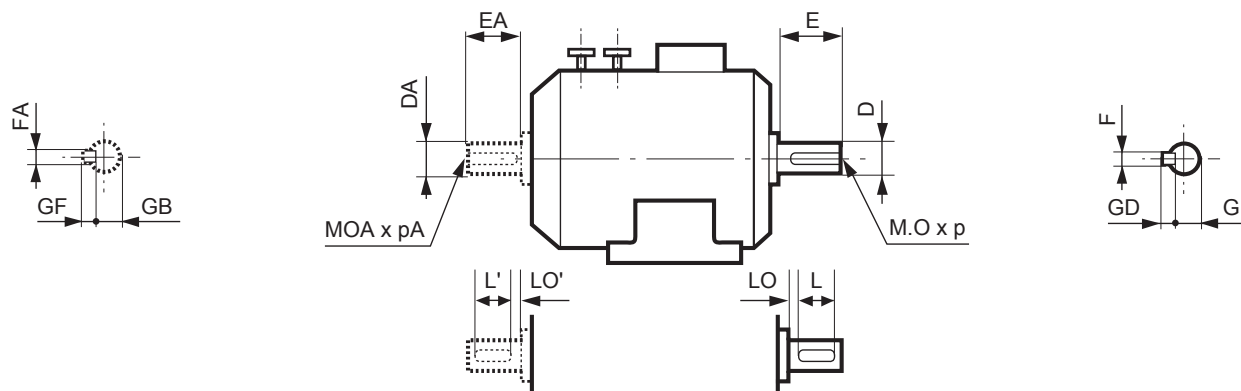

Type	Main shaft extensions																	
	4 and 6 poles									2 poles								
	F	GD	D	G	E	O	p	L	LO	F	GD	D	G	E	O	p	L	LO
LC 315 LA	25	14	90m6	81	170	24	50	140	30	20	12	70m6	62.5	140	20	42	125	15
LC 315 LB	25	14	90m6	81	170	24	50	140	30	20	12	70m6	62.5	140	20	42	125	15
LC 315 LKA	25	14	90m6	81	170	24	50	140	30	20	12	70m6	62.5	140	20	42	125	15
LC 315 LKB	25	14	90m6	81	170	24	50	140	30	20	12	70m6	62.5	140	20	42	125	15
LC 315 LKC (2 & 4 p)	25	14	90m6	81	170	24	50	140	30	20	12	70m6	62.5	140	20	42	125	15
LC 355 LA	28	16	100m6	90	210	24	50	180	30	22	14	80m6	71	170	20	42	140	30
LC 355 LB	28	16	100m6	90	210	24	50	180	30	22	14	80m6	71	170	20	42	140	30
LC 355 LC (4 p)	28	16	100m6	90	210	24	50	180	30	-	-	-	-	-	-	-	-	-
LC 355 LKA	28	16	100m6	90	210	24	50	180	30	22	14	80m6	71	170	20	42	140	30
LC 355 LKB	28	16	100m6	90	210	24	50	180	30	22	14	80m6	71	170	20	42	140	30
LC 355 LKC (6 p)	28	16	100m6	90	210	24	50	180	30	-	-	-	-	-	-	-	-	-
LC 400 LA	28	16	110m6	100	210	24	50	180	30	-	-	-	-	-	-	-	-	-
LC 400 LB (6 p)	28	16	110m6	100	210	24	50	180	30	-	-	-	-	-	-	-	-	-
LC 400 LKA	28	16	110m6	100	210	24	50	180	30	-	-	-	-	-	-	-	-	-
LC 450 LA	32	18	120m6	109	210	24	50	180	30	-	-	-	-	-	-	-	-	-
LC 450 LB	32	18	120m6	109	210	24	50	180	30	-	-	-	-	-	-	-	-	-
LC 500 M/L	36	20	140m6	128	250	30	60	220	30	-	-	-	-	-	-	-	-	-

Type	Secondary shaft extensions																	
	4 and 6 poles									2 poles								
	FA	GF	DA	GB	EA	OA	pA	L'	LO'	FA	GF	DA	GB	EA	OA	pA	L'	LO'
LC 315 LA	20	12	70m6	62.5	140	20	42	125	15	20	12	70m6	62.5	140	20	42	125	15
LC 315 LB	20	12	70m6	62.5	140	20	42	125	15	20	12	70m6	62.5	140	20	42	125	15
LC 315 LKA	20	12	70m6	62.5	140	20	42	125	15	20	12	70m6	62.5	140	20	42	125	15
LC 315 LKB	20	12	70m6	62.5	140	20	42	125	15	20	12	70m6	62.5	140	20	42	125	15
LC 315 LKC (2 & 4 p)	20	12	70m6	62.5	140	20	42	125	15	20	12	70m6	62.5	140	20	42	125	15
LC 355 LA	20	12	70m6	62.5	140	20	42	125	15	20	12	70m6	62.5	140	20	42	125	15
LC 355 LB	20	12	70m6	62.5	140	20	42	125	15	20	12	70m6	62.5	140	20	42	125	15
LC 355 LC (4 p)	20	12	70m6	62.5	140	20	42	125	15	-	-	-	-	-	-	-	-	-
LC 355 LKA	28	16	100m6	90	210	24	50	180	30	22	14	80m6	71	170	20	42	140	30
LC 355 LKB	28	16	100m6	90	210	24	50	180	30	22	14	80m6	71	170	20	42	140	30
LC 355 LKC (6 p)	28	16	100m6	90	210	24	50	180	30	-	-	-	-	-	-	-	-	-
LC 400 LA	28	16	110m6	100	210	24	50	180	30	-	-	-	-	-	-	-	-	-
LC 400 LB (6 p)	28	16	110m6	100	210	24	50	180	30	-	-	-	-	-	-	-	-	-
LC 400 LKA	28	16	110m6	100	210	24	50	180	30	-	-	-	-	-	-	-	-	-
LC 450 LA	32	18	120m6	109	210	24	50	180	30	-	-	-	-	-	-	-	-	-
LC 450 LB	32	18	120m6	109	210	24	50	180	30	-	-	-	-	-	-	-	-	-
LC 500 M/L	36	20	140m6	128	250	30	60	220	30	-	-	-	-	-	-	-	-	-

Mechanical Characteristics
Dimensions - Foot mounted IM 1001 (IM B3)

Dimensions in millimeters

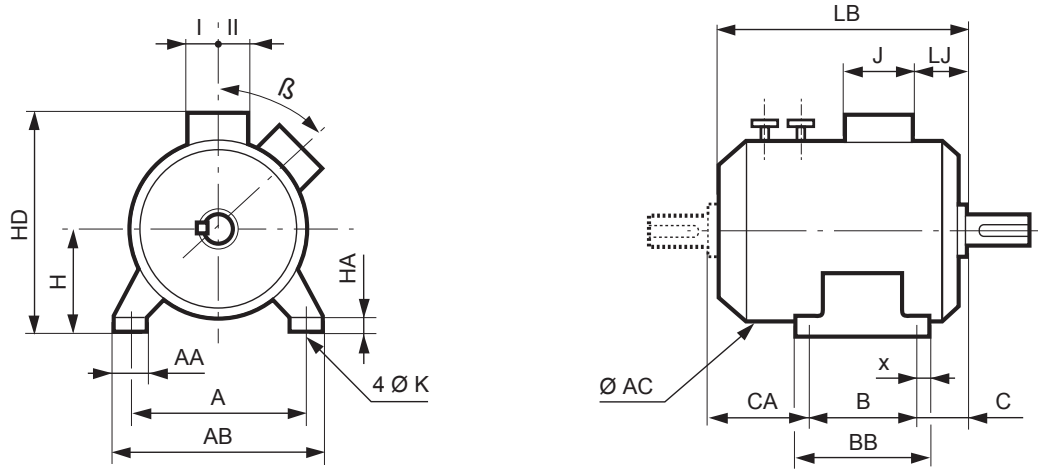

Type	Main dimensions																		
	A	AB	B	BB	C	X	AA	K	HA	H	AC*	HD	LB	LJ	J	I	II	β Vertical TB Angle	CA
LC 315 LA	508	600	508	645	216	58	120	28	35	315	590	843	1090	46	452	220	268	0	376
LC 315 LB	508	600	508	625	216	44	120	28	35	315	590	843	1219	66	452	220	268	0	376
LC 315 LKA	508	600	508	625	216	44	120	28	35	315	680	885	1219	66	452	220	268	0	512
LC 315 LKB	508	600	508	625	216	44	120	28	35	315	680	885	1219	66	452	220	268	0	512
LC 315 LKC (2 & 4 p)	508	600	508	625	216	44	120	28	35	355	680	885	1219	66	452	220	268	0	512
LC 355 LA	610	710	630	765	254	70	120	28	35	355	680	925	1219	66	452	220	268	0	352
LC 355 LB	610	710	630	765	254	70	120	28	35	355	680	925	1219	66	452	220	268	0	352
LC 355 LC (4 p)	610	710	630	765	254	70	120	28	35	355	680	925	1219	66	452	220	268	0	352
LC 355 LKA	610	710	630	765	254	70	120	28	35	355	705	1119	1589	98	700	224	396	45	715
LC 355 LKB	610	710	630	765	254	70	120	28	35	355	705	1119	1589	98	700	224	396	45	715
LC 355 LKC (6 p)	610	710	630	765	254	70	120	28	35	355	705	1119	1589	98	700	224	396	45	715
LC 400 LA	686	800	900	1072	280	92	150	35	35	400	705	1053	1589	98	700	224	396	45	419
LC 400 LB (6 p)	686	800	900	1072	280	92	150	35	35	400	705	1053	1589	98	700	224	396	45	419
LC 400 LKA	686	800	900	1072	280	95	150	35	35	400	800	1081	1789	107	700	224	396	45	619
LC 450 LA	750	890	1000	1165	315	90	150	35	35	450	800	1131	1789	107	700	224	396	45	484
LC 450 LB	750	890	1000	1165	315	90	150	35	35	450	800	1131	1789	107	700	224	396	45	484
LC 500 M	850	990	1400	1590	355	105	220	35	45	500	928	1355	2139	160	1040	400	662	45	694
LC 500 L	850	990	1400	1590	355	105	220	35	45	500	928	1355	2439	160	1040	400	662	45	694

* AC: housing diameter without lifting rings

Mechanical Characteristics

Dimensions - Foot and flange mounted IM 2001 (IM B35)

Dimensions in millimeters

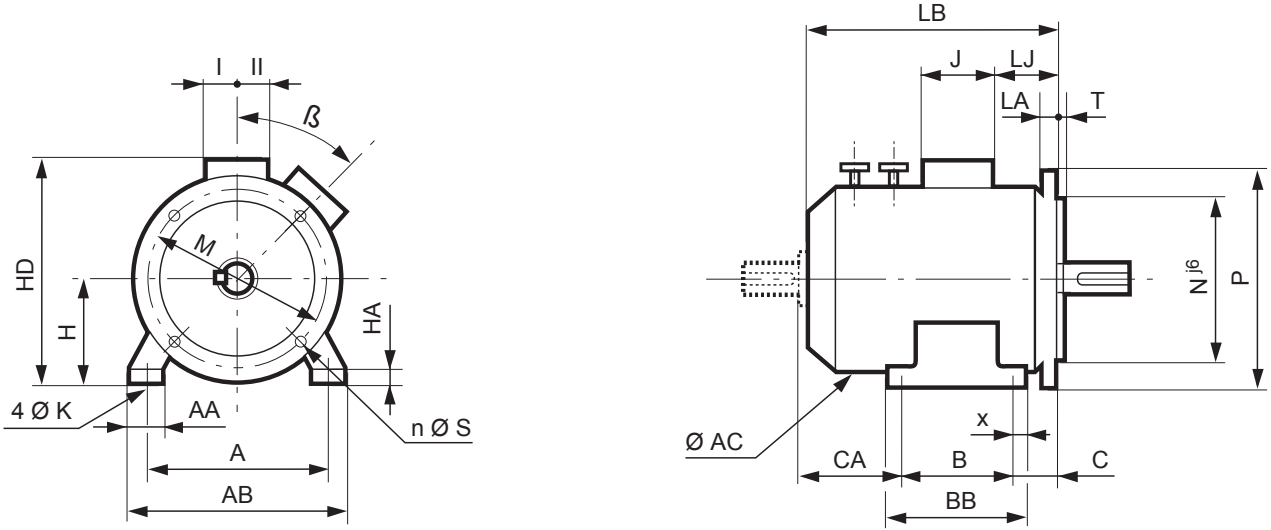

Type	Main dimensions																		
	A	AB	B	BB	C	X	AA	K	HA	H	AC*	HD	LB	LJ	J	I	II	CA	Symb
LC 315 LA	508	600	508	645	216	58	120	28	35	315	590	843	1090	46	452	220	268	376	FF600
LC 315 LB	508	600	508	625	216	44	120	28	35	315	590	843	1219	66	452	220	268	376	FF600
LC 315 LKA	508	600	508	625	216	44	120	28	35	315	680	885	1219	66	452	220	268	512	FF600
LC 315 LKB	508	600	508	625	216	44	120	28	35	315	680	885	1219	66	452	220	268	512	FF600
LC 315 LKC (2 & 4 p)	508	600	508	625	216	44	120	28	35	355	680	885	1219	66	452	220	268	512	FF600
LC 355 LA	610	710	630	765	254	70	120	28	35	355	680	925	1219	66	452	220	268	352	FF740
LC 355 LB	610	710	630	765	254	70	120	28	35	355	680	925	1219	66	452	220	268	352	FF740
LC 355 LC (4 p)	610	710	630	765	254	70	120	28	35	355	680	925	1219	66	452	220	268	352	FF740
LC 355 LKA	610	710	630	765	254	70	120	28	35	355	705	1119	1589	98	700	224	396	715	FF740
LC 355 LKB	610	710	630	765	254	70	120	28	35	355	705	1119	1589	98	700	224	396	715	FF740
LC 355 LKC (6 p)	610	710	630	765	254	70	120	28	35	355	705	1119	1589	98	700	224	396	715	FF740
LC 400 LA	686	800	900	1072	280	92	150	35	35	400	705	1053	1589	98	700	224	396	419	FF940
LC 400 LB (6 p)	686	800	900	1072	280	92	150	35	35	400	705	1053	1589	98	700	224	396	419	FF940
LC 400 LKA	686	800	900	1072	280	95	150	35	35	400	800	1081	1789	107	700	224	396	619	FF940
LC 450 LA	750	890	1000	1165	315	90	150	35	35	450	800	1131	1789	107	700	224	396	484	FF1080
LC 450 LB	750	890	1000	1165	315	90	150	35	35	450	800	1131	1789	107	700	224	396	484	FF1080
LC 500 M	850	990	1400	1590	355	105	220	35	45	500	928	1355	2139	160	1040	400	662	694	FF1080
LC 500 L	850	990	1400	1590	355	105	220	35	45	500	928	1355	2439	160	1040	400	662	694	FF1080

* AC: housing diameter without lifting rings

Mechanical Characteristics

Dimensions - Flange mounted IM 3001 (IM B5) IM 3011 (IM V1)

Dimensions in millimeters

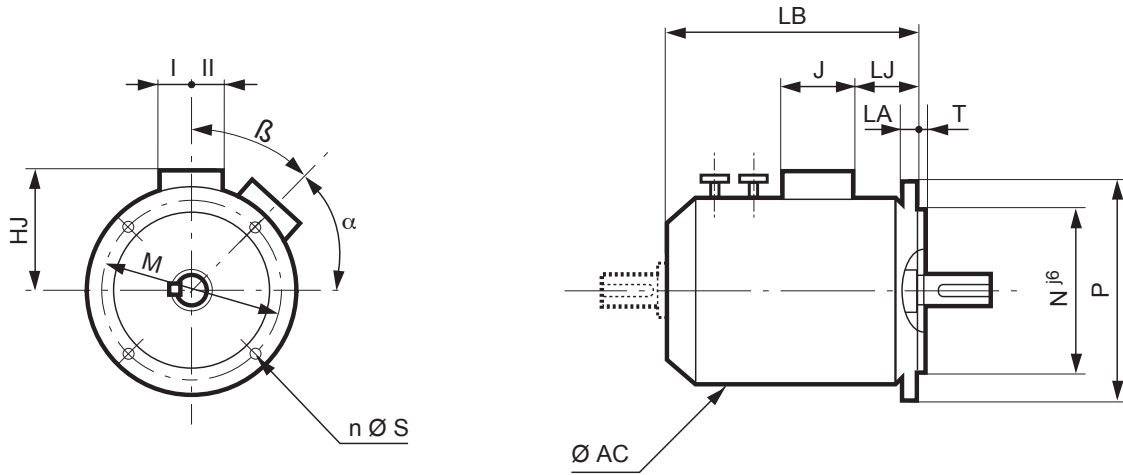

IEC symbol	Flange dimensions							
	M	N	P	T	n	α°	S	LA
FF600	600	550	660	6	8	22,5	24	25
FF600	600	550	660	6	8	22,5	24	25
FF600	600	550	660	6	8	22,5	24	25
FF600	600	550	660	6	8	22,5	24	25
FF600	600	550	660	6	8	22,5	24	25
FF740	740	680	800	6	8	22,5	24	25
FF740	740	680	800	6	8	22,5	24	25
FF740	740	680	800	6	8	22,5	24	25
FF740	740	680	800	6	8	22,5	24	25
FF740	740	680	800	6	8	22,5	24	25
FF740	740	680	800	6	8	22,5	24	25
FF940	940	880	1000	6	8	22,5	28	30
FF940	940	880	1000	6	8	22,5	28	30
FF940	940	880	1000	6	8	22,5	28	30
FF1080	1080	1000	1150	6	8	22,5	28	30
FF1080	1080	1000	1150	6	8	22,5	28	30
FF1080	1080	1000	1150	6	8	22,5	28	30
FF1080	1080	1000	1150	6	8	22,5	28	30

Type	Main dimensions						
	AC*	LB	HJ	LJ	J	I	II
LC 315 LA	590	1090	528	46	452	220	268
LC 315 LB	590	1219	528	66	452	220	268
LC 315 LKA	680	1219	570	66	452	220	268
LC 315 LKB	680	1219	570	66	452	220	268
LC 315 LKC (2 & 4 p)	680	1219	530	66	452	220	268
LC 355 LA	680	1219	570	66	452	220	268
LC 355 LB	680	1219	570	66	452	220	268
LC 355 LC (4 p)	680	1219	570	66	452	220	268
LC 355 LKA	705	1589	764	98	700	224	396
LC 355 LKB	705	1589	764	98	700	224	396
LC 355 LKC (6 p)	705	1589	764	98	700	224	396
LC 400 LA	705	1589	653	98	700	224	396
LC 400 LB (6 p)	705	1589	653	98	700	224	396
LC 400 LKA	800	1789	681	107	700	224	396
LC 450 LA	800	1789	681	107	700	224	396
LC 450 LB	800	1789	681	107	700	224	396
LC 500 M	928	2139	855	160	1040	400	662
LC 500 L	928	2439	855	160	1040	400	662

* AC: housing diameter without lifting rings

CAUTION: position IM3001 (IM B5) is not permitted for the LC 500 motor, and is available on request for other frame sizes.

Mechanical Characteristics Dimensions - Water Connecting Flange

Dimensions in millimeters

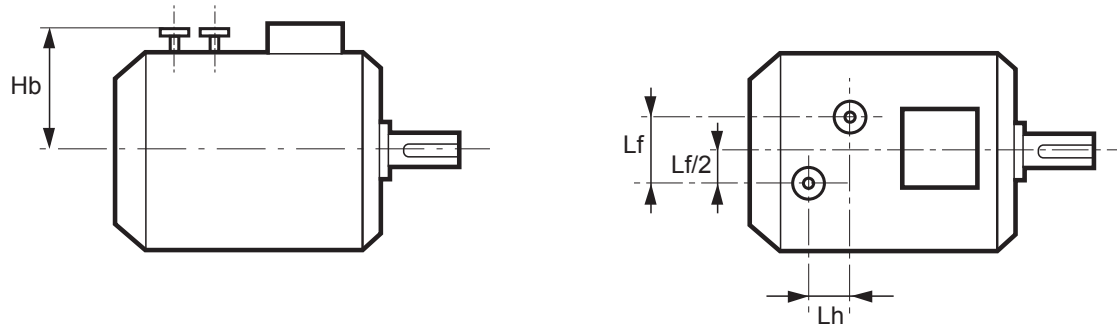

Type	Water connecting flange dimensions			
	Size	Lf	Lh	Hb
LC 315 LA	DN25-PN16 EN1092-1	140	0	340
LC 315 LB	DN25-PN16 EN1092-1	140	0	340
LC 315 LKA	DN32-PN16 EN1092-1	160	0	380
LC 315 LKB	DN32-PN16 EN1092-1	160	0	380
LC 315 LKC (2 & 4 p)	DN32-PN16 EN1092-1	160	0	380
LC 355 LA	DN32-PN16 EN1092-1	160	0	380
LC 355 LB	DN32-PN16 EN1092-1	160	0	380
LC 355 LC (4 p)	DN32-PN16 EN1092-1	160	0	380
LC 355 LKA	DN50-PN16 EN1092-1	180	150	385
LC 355 LKB	DN50-PN16 EN1092-1	180	150	385
LC 355 LKC (6 p)	DN50-PN16 EN1092-1	180	150	385
LC 400 LA	DN50-PN16 EN1092-1	180	150	385
LC 400 LB (6 p)	DN50-PN16 EN1092-1	180	150	385
LC 400 LKA	DN50-PN16 EN1092-1	180	150	435
LC 450 LA	DN50-PN16 EN1092-1	180	150	435
LC 450 LB	DN50-PN16 EN1092-1	180	150	435
LC 500 M/L	DN50-PN16 EN1092-1	180	150	500

Mechanical Characteristics Bearings and Lubrication

BEARINGS WITH GREASE NIPPLES

The table below indicates the greasing intervals, depending on the type of motor, for a horizontal shaft machine operating at an ambient temperature of 25°C, 40°C and 55°C.

The chart below is valid for LC motors lubricated with Polyrex EM103 grease, which is used as standard.

SPECIAL CONSTRUCTION AND ENVIRONMENT



For vertical shaft machines, the greasing intervals will be approximately 50% of the values stated in the table below.

Note: The quality and quantity of grease and the greasing interval are shown on the machine nameplate.

Instructions for bearing maintenance are given on the nameplates on these machines.

Series	Type	Number of poles	Type of bearing for bearings with grease nipples		Quantity of grease g	Greasing intervals in hours								
			NDE	DE		3000 rpm			1500 rpm			1000 rpm		
						25°C	40°C	55°C	25°C	40°C	55°C	25°C	40°C	55°C
LC	315 LA	2	6316 C3	6218 C3	33	7500	3700	2400	-	-	-	-	-	-
	315 LA	4; 6	6316 C3	6320 C3	51	-	-	-	16600	10400	6500	26100	26100	20700
	315 LB	2	6316 C3	6218 C3	33	7500	3700	3000	-	-	-	-	-	-
	315 LB	4; 6	6316 C3	6320 C3	51	-	-	-	16600	10400	6500	26100	26100	16400
	315 LKA	2	6316 C3	6218 C3	33	7500	7500	3700	-	-	-	-	-	-
	315 LKA	4; 6	6316 C3	6322 C3	60	-	-	-	14300	9000	4500	23600	23600	11800
	315 LKB	2	6316 C3	6218 C3	33	7500	4700	3000	-	-	-	-	-	-
	315 LKB	4; 6	6316 C3	6322 C3	60	-	-	-	14300	7100	3600	23600	23600	11800
	315 LKC	2	6316 C3	6218 C3	33	7500	4700	3000	-	-	-	-	-	-
	315 LKC	4	6316 C3	6322 C3	60	-	-	-	14300	7100	4500	-	-	-
	355 LA	2	6316 C3	6218 C3	33	7500	3700	1900	-	-	-	-	-	-
	355 LA	4; 6	6316 C3	6322 C3	60	-	-	-	11300	7100	3600	23600	18700	11800
	355 LB	2	6316 C3	6218 C3	33	7500	3700	1900	-	-	-	-	-	-
	355 LB	4; 6	6316 C3	6322 C3	60	-	-	-	14300	7100	3600	23600	18700	11800
	355 LC	4	6316 C3	6322 C3	60	-	-	-	14300	14300	11300	-	-	-
	355 LKA	2	6317 C3	6317 C3	37	6600	6600	5200	-	-	-	-	-	-
	355 LKA	4; 6	6324 C3	6324 C3	72	-	-	-	10000	6300	3100	21600	21600	13600
	355 LKB	2	6317 C3	6317 C3	37	6600	6600	6600	-	-	-	-	-	-
	355 LKB	4; 6	6324 C3	6324 C3	72	-	-	-	12500	12500	12500	21600	21600	21600
	400 LA	4; 6	6324 C3	6324 C3	72	-	-	-	12500	12500	12500	21600	21600	21600
	400 LB	6	6324 C3	6324 C3	72	-	-	-	-	-	-	21600	21600	21600
	400 LKA	4; 6	6324 C3	6326 C3	81	-	-	-	11000	8800	5500	19800	9900	6200
	450 LA	4; 6	6324 C3	6326 C3	81	-	-	-	16500	11000	11000	19800	9900	6200
	450 LB	4; 6	6324 C3	6326 C3	81	-	-	-	16500	11000	11000	19800	19800	19800
500 M/L	4; 6	6330 C3	6330 C3	104	-	-	-	8500	8500	8500	16700	16700	16700	
in position V1 (IM3011)														
400 LKA	4; 6	6324 C3	7326	81	-	-	-	5500	4400	2750	9900	4950	3100	
450 LA	4; 6	6324 C3	7326	81	-	-	-	8250	5500	5500	9900	4950	3100	
450 LB	4; 6	6324 C3	7326	81	-	-	-	8250	5500	5500	9900	9900	9900	
500 M/L	4; 6	6330 C3	7330	104	-	-	-	4250	4250	4250	8350	8350	8350	

The DE bearing is locked, regardless type of mounting.

Mechanical Characteristics Axial Loads

HORIZONTAL MOTOR

For a bearing life L_{10h}
at 25,000 hours
and 40,000 hours

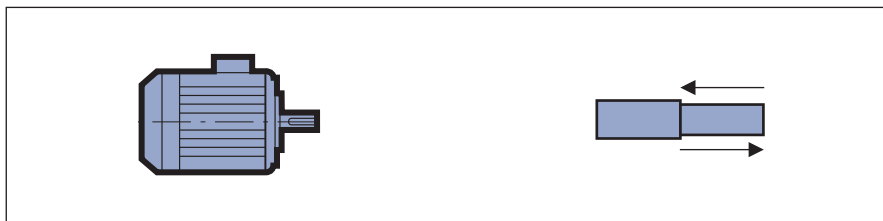

Series	Type	Number of poles	Permissible axial load (in daN) on main shaft extension for standard bearing assembly													
			3000 rpm						1500 rpm				1000 rpm			
			→		←		→		←		→		←			
			25,000 hours	40,000 hours	25,000 hours	40,000 hours	25,000 hours	40,000 hours	25,000 hours	40,000 hours	25,000 hours	40,000 hours	25,000 hours	40,000 hours		
LC	315 LA	2; 4; 6	405	343	165	103	786	646	546	406	897	724	657	484		
	315 LB	2; 4; 6	400	338	160	98	778	639	538	399	882	710	642	470		
	315 LKA	2; 4; 6	400	342	100	42	745	617	445	317	746	599	446	299		
	315 LKB	2; 4; 6	400	342	100	42	731	602	431	302	730	583	430	283		
	315 LKC	2; 4	400	342	100	42	701	571	401	271	-	-	-	-		
	355 LA	2; 4; 6	399	341	99	41	826	682	526	382	893	721	593	421		
	355 LB	2; 4; 6	388	332	88	32	800	659	500	359	875	705	575	405		
	355 LC	4	-	-	-	-	740	599	560	419	-	-	-	-		
	355 LKA	2; 4; 6	537	456	235	154	1026	870	421	265	1154	958	549	353		
	355 LKB	2; 4; 6	514	436	212	133	1008	8548	403	250	1154	958	549	353		
	400 LA	4; 6	-	-	-	-	939	793	334	189	1130	938	525	333		
	400 LB	6	-	-	-	-	-	-	-	-	1040	862	436	257		
	400 LKA	4; 6	-	-	-	-	818	657	415	254	917	737	513	333		
	450 LA	4; 6	-	-	-	-	796	634	393	230	866	682	462	279		
	450 LB	4; 6	-	-	-	-	817	655	414	252	866	682	462	279		
	500 M/L	4; 6	-	-	-	-	751	-	206	-	842	-	298	-		

CAUTION: position IM3001 (IM B5) is not permitted for the LC 500 motor, and is available on request for other frame sizes.

Mechanical Characteristics

Axial Loads

VERTICAL MOTOR SHAFT FACING DOWN

For a bearing life L_{10h}
at 25,000 hours
and 40,000 hours



Series	Type	Number of poles	Permissible axial load (in daN) on main shaft extension for standard bearing assembly											
			3000 rpm				1500 rpm				1000 rpm			
			25,000 hours	40,000 hours	25,000 hours	40,000 hours	25,000 hours	40,000 hours	25,000 hours	40,000 hours	25,000 hours	40,000 hours	25,000 hours	40,000 hours
LC	315 LA	2 ; 4 ; 6	240	170	443	373	567	415	941	789	660	490	1094	924
	315 LB	2 ; 4 ; 6	231	161	448	378	553	401	949	797	660	490	1094	924
	315 LKA	2 ; 4 ; 6	126	56	553	483	558	395	1128	964	508	306	1424	1221
	315 LKB	2 ; 4 ; 6	126	55	56	483	521	358	1155	993	426	223	1520	1317
	315 LKC	2 ; 4	126	55	56	483	481	320	1164	1004	-	-	-	-
	355 LA	2 ; 4 ; 6	60	9	619	549	476	315	1168	1008	503	300	1427	1225
	355 LB	2 ; 4 ; 6	125	55	557	487	351	189	1311	1149	420	218	1523	1321
	355 LC	4	-	-	-	-	291	129	1371	1209	-	-	-	-
	355 LKA	2 ; 4 ; 6	291	200	646	555	492	312	1299	1120	569	365	1533	1329
	355 LKB	2 ; 4 ; 6	258	167	667	576	454	275	1327	1149	569	365	1533	1329
	400 LA	4 ; 6	-	-	-	-	227	50	1536	1359	514	310	1586	1382
	400 LB	6	-	-	-	-	-	-	-	-	346	141	1721	1516
	400 LKA	4 ; 6	-	-	-	-	2662	2087	815	815	3037	2379	1200	1200
	450 LA	4 ; 6	-	-	-	-	2637	2062	818	818	2919	2261	1301	1301
	450 LB	4 ; 6	-	-	-	-	2637	2062	818	818	2919	2261	1301	1301
	500 M/L	4 ; 6	-	-	-	-	2185	1541	1489	1489	2463	1725	2236	2236

Mechanical Characteristics

Radial Loads

PERMISSIBLE RADIAL LOAD ON THE MAIN SHAFT EXTENSION

In pulley and belt couplings, the drive shaft carrying the pulley is subjected to a radial force F_{pr} applied at a distance X (mm) from the shoulder of the shaft extension (length E).

Radial force acting on the drive shaft: F_{pr}

The radial force F_{pr} expressed in daN applied to the drive shaft is found by the formula.

$$F_{pr} = 1.91 \cdot 10^6 \frac{P_N \cdot k}{D \cdot N_N} \pm P_P$$

where:

P_N = rated motor power (kW)

D = external diameter of the drive pulley (mm)

N_N = rated speed of the motor (rpm)

k = factor depending on the type of transmission

P_P = weight of the pulley (daN)

The weight of the pulley is positive when it acts in the same direction as the tension force in the belt (and negative when it acts in the opposite direction).

Range of values for factor k (*)

- toothed belts: $k = 1$ to 1.5

- V-belts: $k = 2$ to 2.5

- flat belts

• with tensioner: $k = 2.5$ to 3

• without tensioner: $k = 3$ to 4

(*) A more accurate figure for factor k can be obtained from the transmission suppliers.

Permissible radial force on the drive shaft:

The charts on the following pages indicate, for each type of motor, the radial force F_R at a distance X permissible on the drive end shaft extension, for a bearing life L_{10h} of 25,000 hours.

Note: The selection charts are applicable for a motor installed with the shaft horizontal.

Change in bearing life according to the radial load factor

For a radial load F_{pr} ($F_{pr} \neq F_R$), applied at distance X , the bearing life L_{10h} changes, as a rough estimate, in the ratio k_R , ($k_R = F_{pr}/F_R$) as shown in the chart below, for standard fitting arrangements.

If the load factor k_R is greater than 1.05, you should consult our technical department, stating mounting position and direction of force before opting for a special fitting arrangement.

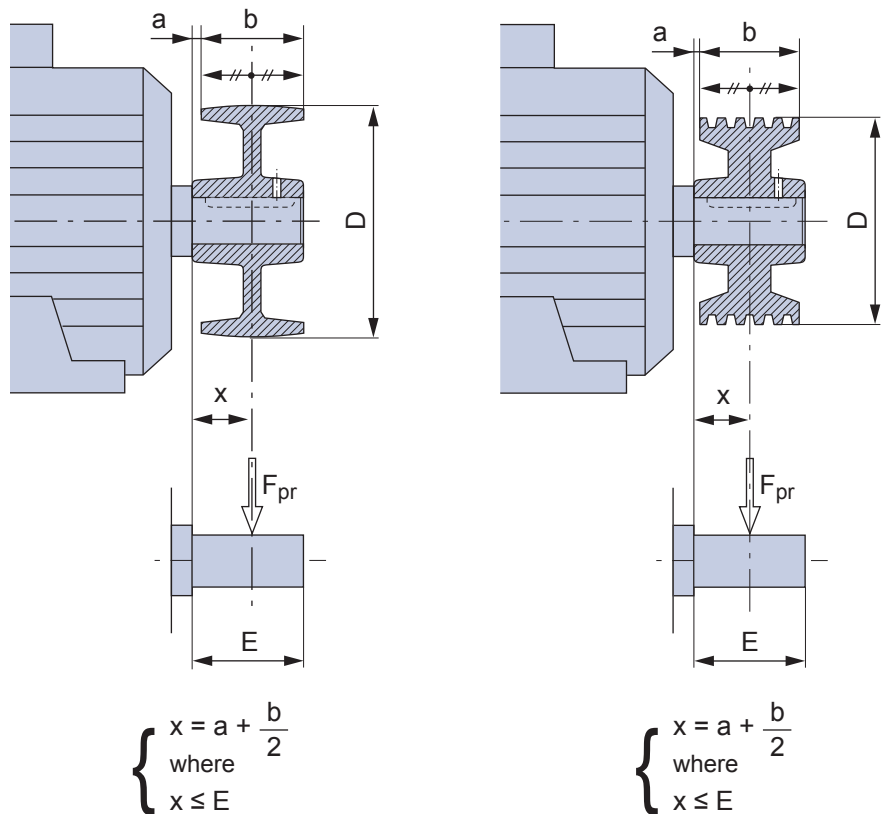

Mechanical Characteristics
Radial Loads

STANDARD FITTING ARRANGEMENT

Permissible radial load on main shaft extension with a bearing life L_{10h} of 25,000 hours.

FR: Radial Force

X: distance with respect to the shaft shoulder

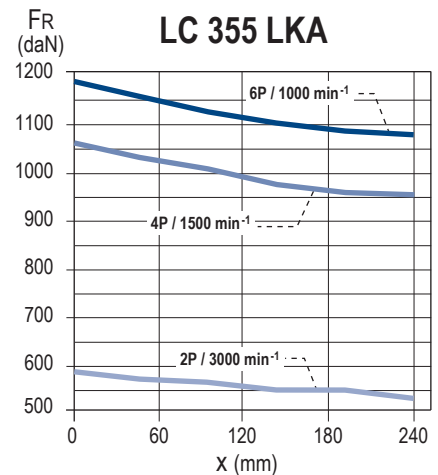
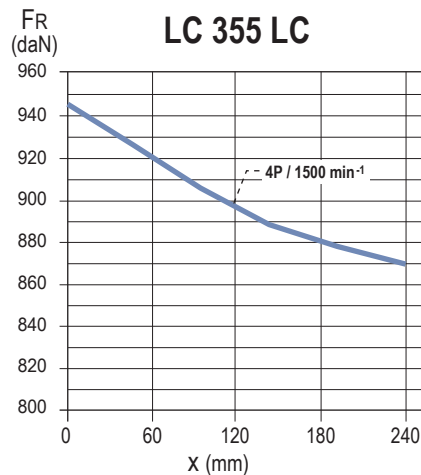
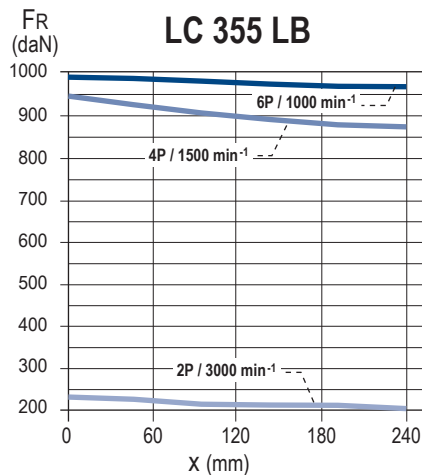
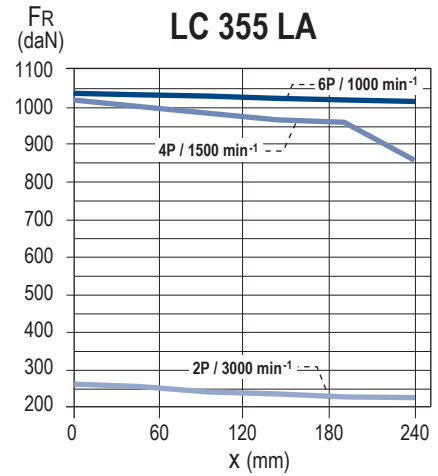
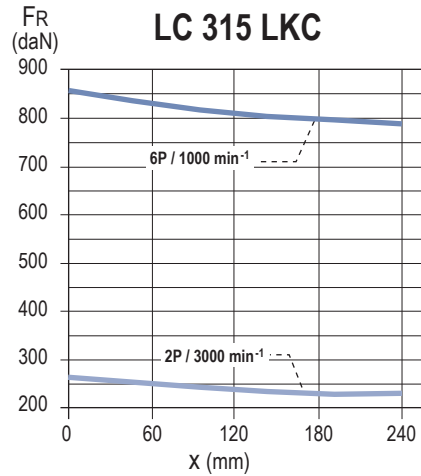
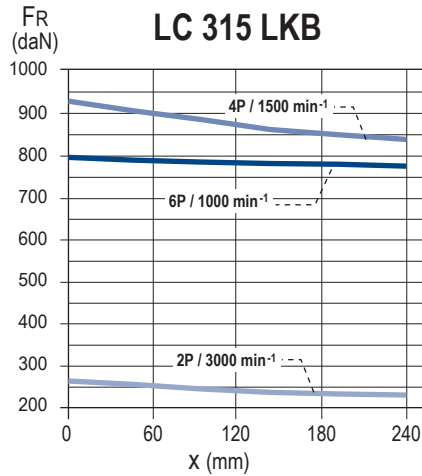
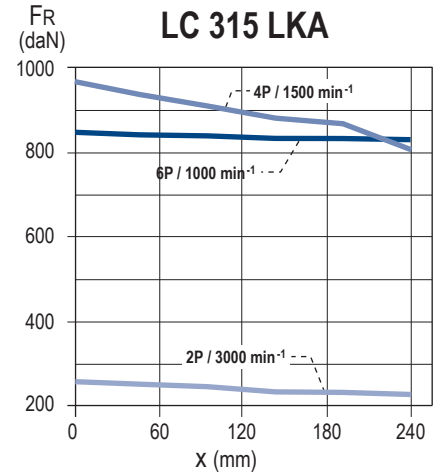
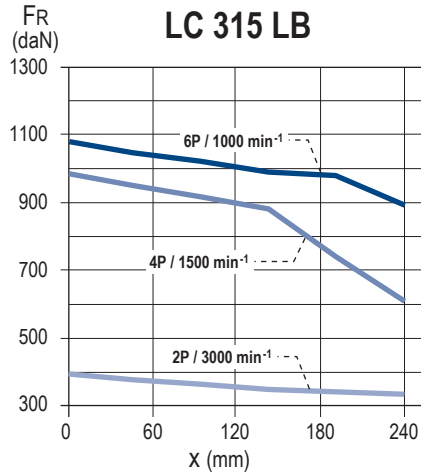
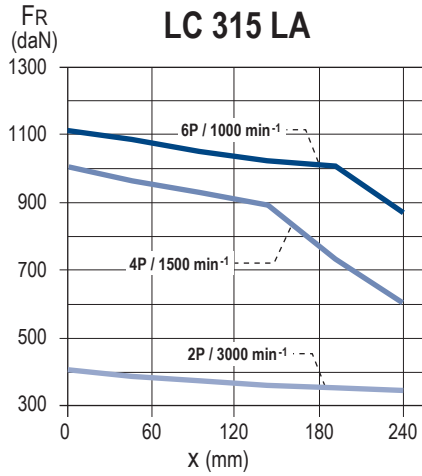

Mechanical Characteristics
Radial Loads

STANDARD FITTING ARRANGEMENT

Permissible radial load on main shaft extension with a bearing life L_{10h} of 25,000 hours.

FR: Radial Force

X: distance with respect to the shaft shoulder

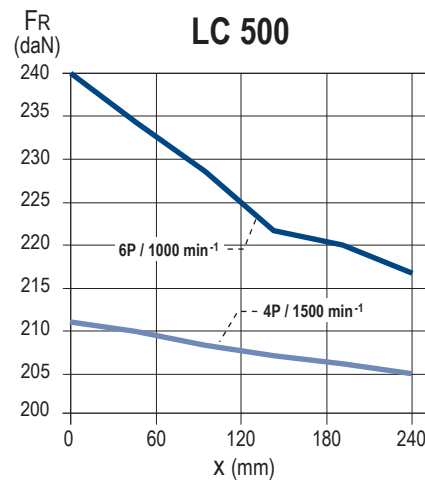
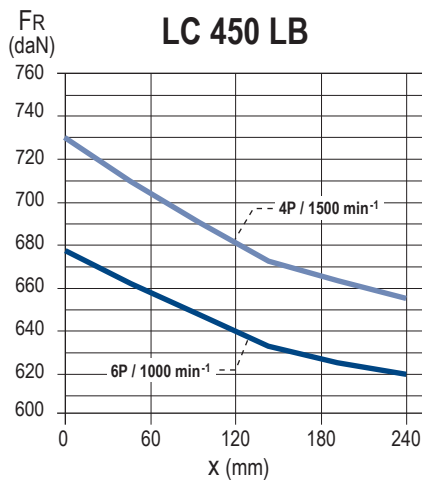
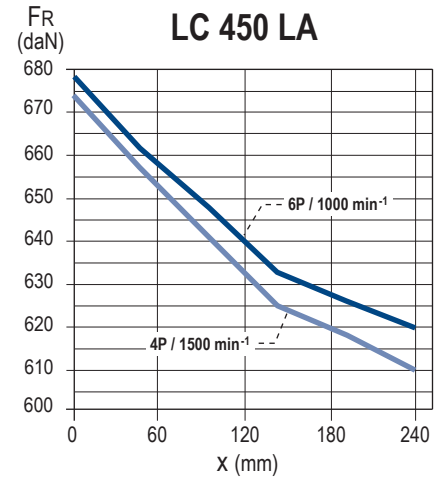
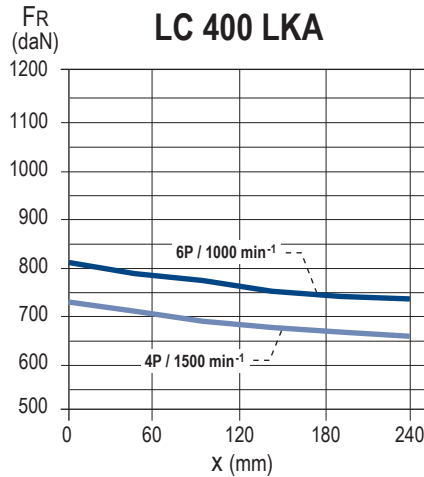
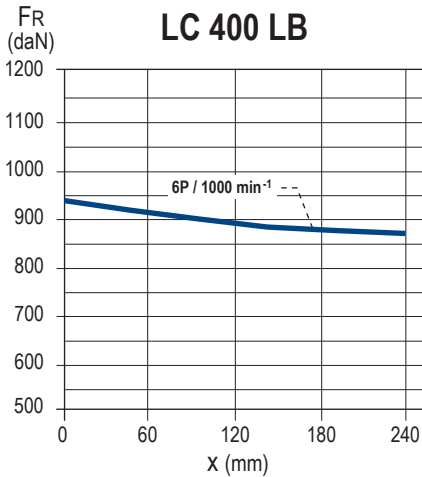
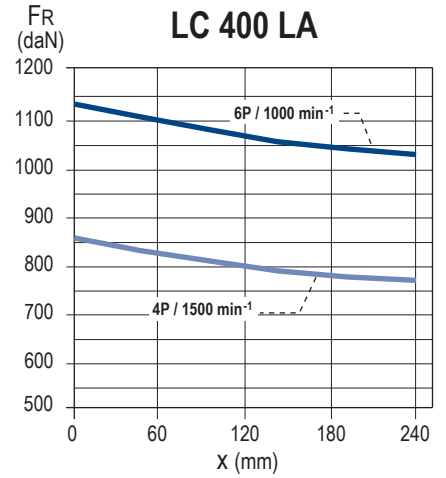
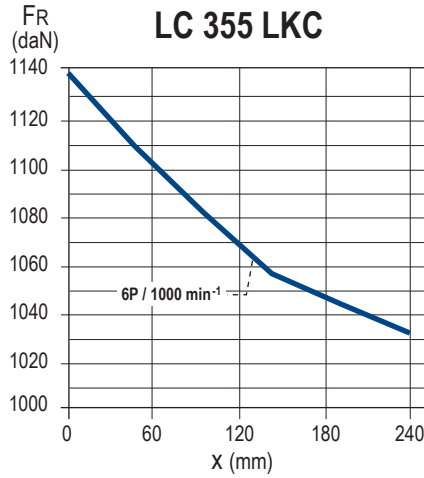
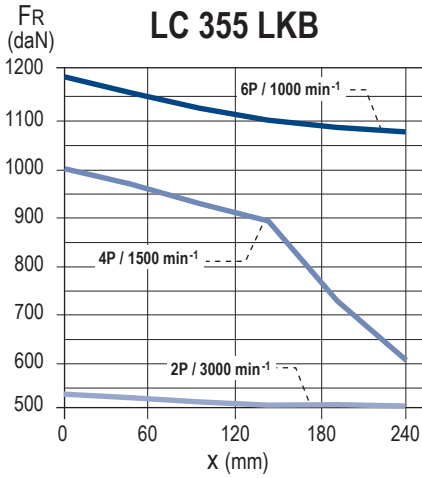

Mechanical Characteristics

Radial Loads

SPECIAL FITTING ARRANGEMENT

Type of drive end roller bearings

Series	Type	Number of poles	Non-drive end bearing (NDE)	Drive end bearing (DE)
LC	315 LA	4 ; 6	6316 C3	NU320
	315 LB	4 ; 6	6316 C3	NU320
	315 LKA	4 ; 6	6316 C3	NU322
	315 LKB	4 ; 6	6316 C3	NU322
	315 LKC	4	6316 C3	NU322
	355 LA	4 ; 6	6316 C3	NU322
	355 LB	4 ; 6	6316 C3	NU322
	355 LC	4	6316 C3	NU322
	355 LKA	4 ; 6	6324 C3	NU324
	355 LKB	4 ; 6	6324 C3	NU324
	400 LA	4 ; 6	6324 C3	NU324
	400 LB	6	6324 C3	NU324
	400 LKA	4 ; 6	6324 C3	NU326
	450 LA	4 ; 6	6324 C3	NU326
	450 LB	4 ; 6	6324 C3	NU326
	500 M/L	4 ; 6	6330 C3	NU330

Mechanical Characteristics
Radial Loads

SPECIAL FITTING ARRANGEMENT

Permissible radial load on main shaft extension with a bearing life L_{10h} of 25,000 hours.

FR: Radial Force

X: distance with respect to the shaft shoulder

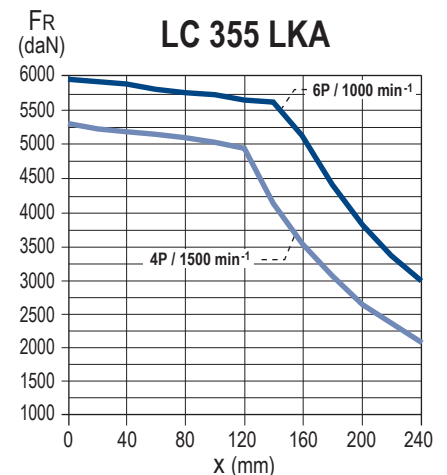
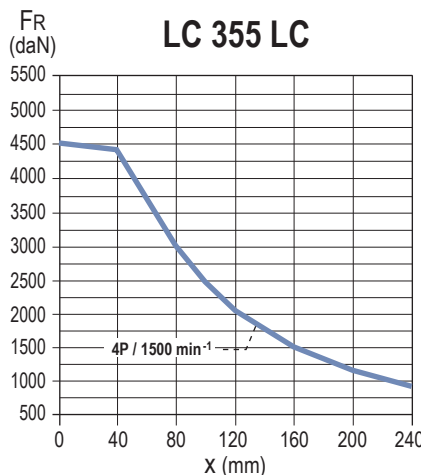
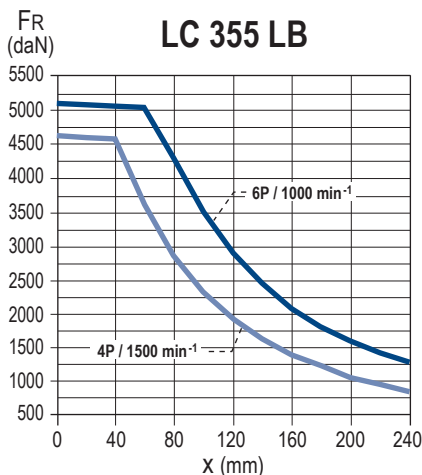
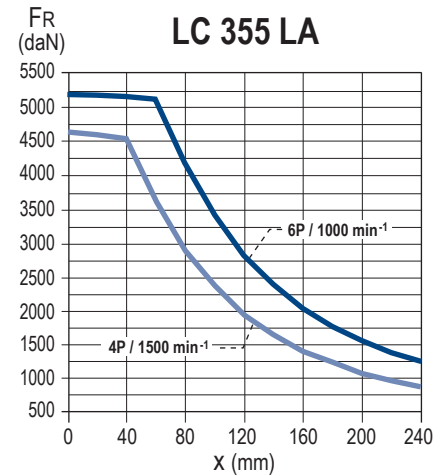
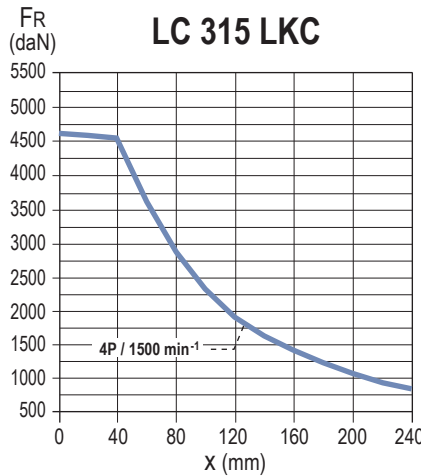
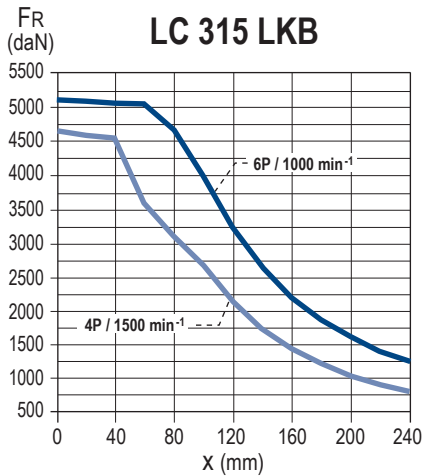
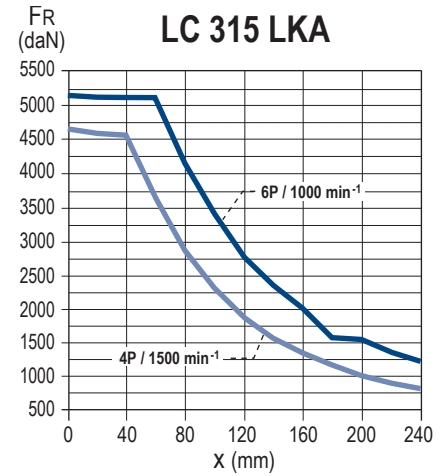
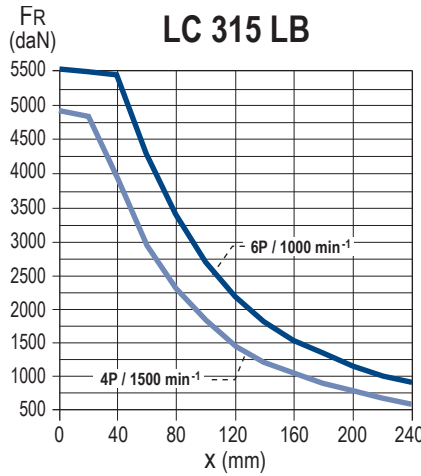
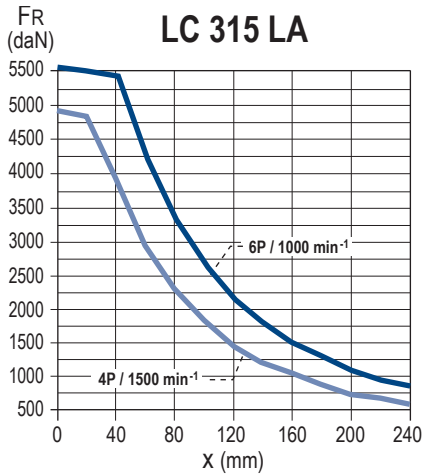

Mechanical Characteristics
Radial Loads

SPECIAL FITTING ARRANGEMENT

Permissible radial load on main shaft extension with a bearing life L_{10h} of 25,000 hours.

FR: Radial Force

X: distance with respect to the shaft shoulder

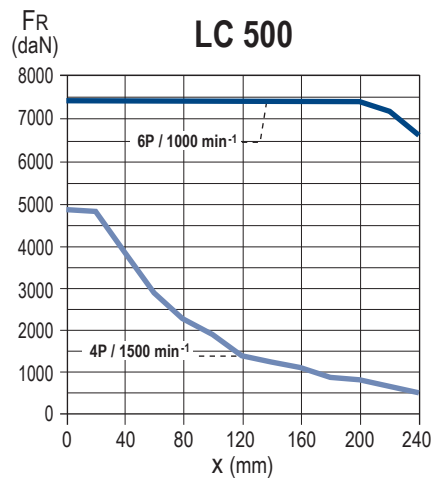
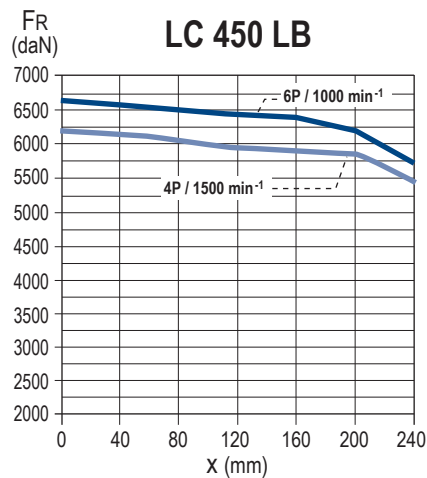
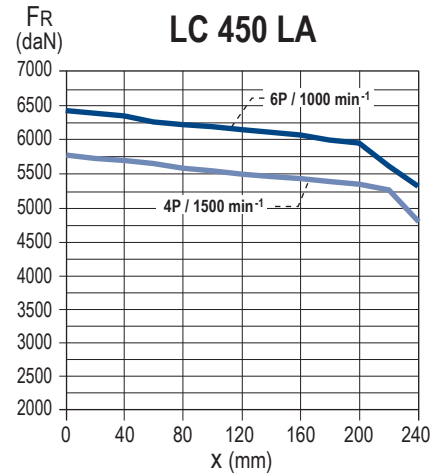
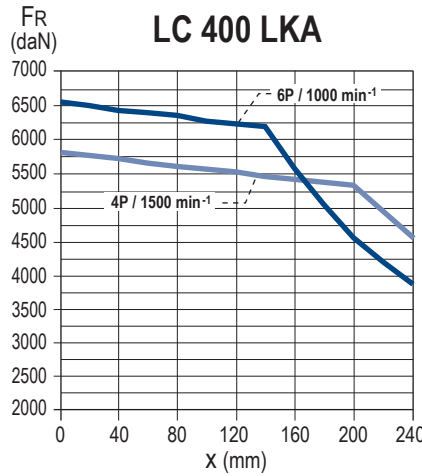
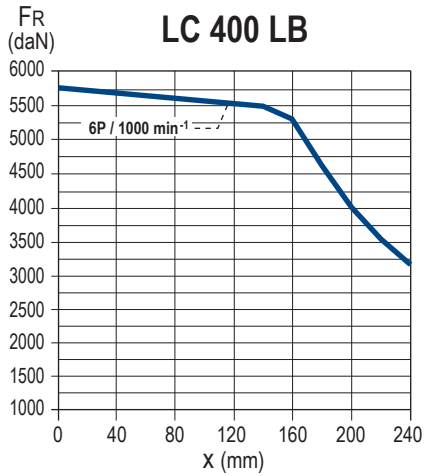
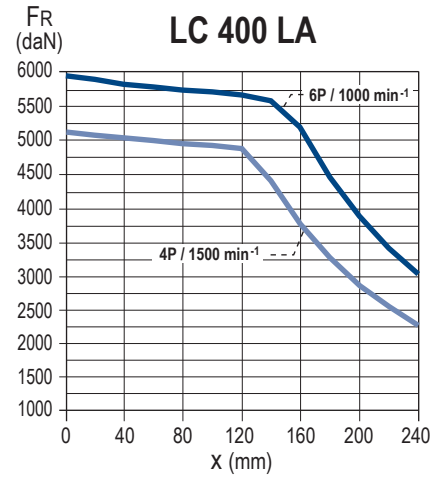
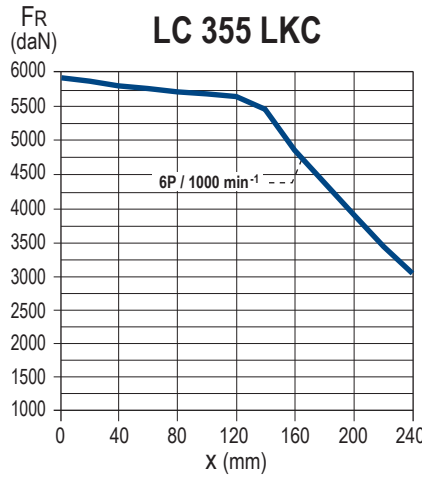
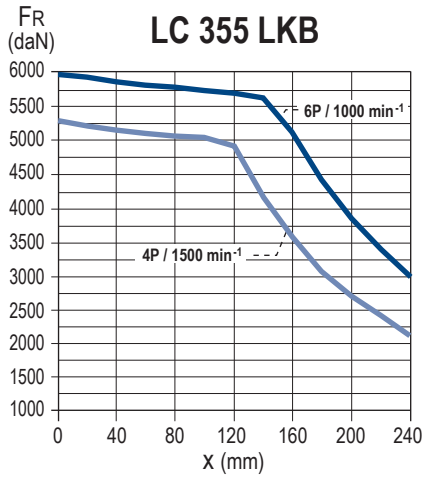

Appendix Calculating the Efficiency of an Induction Motor

MACHINE EFFICIENCY

Efficiency is the ratio between the output power (needed to drive a machine) and the power absorbed (power consumed). This value is therefore necessarily less than 1. The difference between the output power and the power absorbed consists of the electrical machine losses. 85% efficiency therefore means there are 15% losses.

Direct measurement method

With the direct method, efficiency is calculated using mechanical (torque C and speed Ω) and electrical (power absorbed P_{abs}) measurements. If the measuring tools are specified (use of a torquemeter), this method has the advantage of being relatively easy. However, it does not provide any information about machine performance and the origins of the potential losses.

$$\eta = \frac{P_u}{P_{abs}} \text{ where } P_u = C \Omega$$

Indirect measurement methods

These methods determine efficiency by determining the machine losses. Conventionally, a distinction is made between three types of losses: joule losses (stator P_{js} and rotor P_{jr}), iron losses (P_f) and mechanical losses (P_m) which are relatively easy to measure. Miscellaneous losses called additional losses are added to these losses; they are more difficult to determine.

In standard IEC 60034-2 dated 1972 and applicable until November 2010, the method for calculating additional losses uses a fixed percentage of 0.5% of the power absorbed.

$$\eta = \frac{P_{abs} - P_{js} - P_{jr} - P_f - P_m - P_{sup}}{P_{abs}} \text{ where } P_{sup} = 0.5\% P_{abs}$$

Additional losses come from a variety of sources: surface losses, busbar currents, high-frequency losses, losses linked to leakage flux, etc. They are specific to each machine and contribute to reducing efficiency but they are very complex to calculate from a quantitative point of view.

In the standard IEC 60034-2-1 dated September 2007, these additional losses must be measured precisely. This is a similar approach to that taken by the North American IEEE112-B and Canadian (CSA390) standards, which deduct the additional losses from a thermally-stable on-load curve.

The residual losses are calculated at each load point: 25%, 50%, 75%, 100%, 115% and 125%:

$$P_{res} = P_{abs} - P_{js} - P_{jr} - P_f - P_m - P_u \text{ where } P_u = C \Omega$$

The straight line is drawn by approximating the curve points as closely as possible. The measurement is acceptable if a correlation coefficient of 0.95 or higher can be ensured.

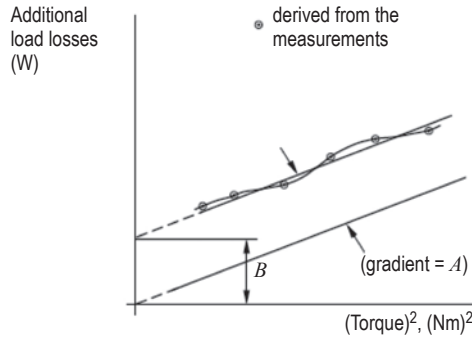

The line to 0 gives the additional losses at the nominal point, i.e. at 100% load.

From then on, the usual equation gives the efficiency:

$$\eta = \frac{P_{abs} - P_{js} - P_{jr} - P_f - P_m - P_{sup}}{P_{abs}}$$

Note that with this method, the Joule losses must be corrected according to the temperature and the iron losses corrected according to the resistive voltage dip in the stator.

Appendix Units of Measurement and Standard Formulae

ELECTRICITY AND ELECTROMAGNETISM

Parameters				Unit		Units and expressions not recommended
French name	English name	Symbol	Definition	SI	Non SI, but accepted	Conversion
Fréquence Période	Frequency	f		Hz (hertz)		
Courant électrique (intensité de)	Electric current	I		A (ampere)		
Potentiel électrique Tension Force électromotrice	Electric potential Voltage Electromotive force	V U E		V (volt)		
Déphasage	Phase angle	φ		rad	° degree	
Facteur de puissance	Power factor	$\cos \varphi$				
Réactance Résistance Impédance	Reactance Resistance Impedance	X R Z		Ω (ohm)		j is defined as $j^2 = -1$ ω rotational frequency = $2 \pi \cdot f$
Inductance propre (self)	Self inductance	L		H (henry)		
Capacité	Capacitance	C		F (farad)		
Charge électrique, Quantité d'électricité	Quantity of electricity	Q		C (coulomb)	A.h 1 A.h = 3600 C	
Résistivité	Resistivity	ρ		$\Omega \cdot m$		Ω/m
Conductance	Conductance	G		S (siemens)		$1/\Omega = 1 \text{ S}$
Nombre de tours, (spires) de l'enroulement Nombre de phases Nombre de paires de pôles	N° of turns (coil) N° of phases N° of pairs of poles	N m p				
Champ magnétique	Magnetic field	H		A/m		
Différence de potentiel magnétique Force magnétomotrice Solénation, courant totalisé	Magnetic potential difference Magnetomotive force	Um F, Fm H		A		The unit AT (ampere-turns) is incorrect because it treats "turn" as a physical unit
Induction magnétique, Densité de flux magnétique	Magnetic induction Magnetic flux density	B		T (tesla) = Wb/m ²		(gauss) $1 \text{ G} = 10^{-4} \text{ T}$
Flux magnétique, Flux d'induction magnétique	Magnetic flux	Φ		Wb (weber)		(maxwell) $1 \text{ max} = 10^{-8} \text{ Wb}$
Potentiel vecteur magnétique	Magnetic vector potential	A		Wb/m		
Perméabilité d'un milieu Perméabilité du vide	Permeability Permeability of vacuum	$\mu = \mu_o \mu_r$ μ_o		H/m		
Permittivité	Permittivity	$\epsilon = \epsilon_o \epsilon_r$		F/m		

Appendix Units of Measurement and Standard Formulae

THERMODYNAMICS

Parameters				Unit		Units and expressions not recommended
French name	English name	Symbol	Definition	SI	Non SI, but accepted	Conversion
Température Thermodynamique	Temperature Thermodynamic	T		K (kelvin)	temperature Celsius, t , °C $T = t + 273.15$	°C: degree Celsius t_C : temp. in °C t_F : temp. in °F f temperature Fahrenheit °F
Écart de température	Temperature rise	ΔT		K	°C	1 °C = 1 K
Densité de flux thermique	Heat flux density	q, φ		W/m ²		
Conductivité thermique	Thermal conductivity	λ		W/m.K		
Coefficient de transmission thermique global	Total heat transmission coefficient	K		W/m ² .K		
Capacité thermique	Heat capacity	C		J/K		
Capacité thermique massique	Specific heat capacity	c		J/kg.K		
Énergie interne	Internal energy	U		J		

NOISE AND VIBRATION

Parameters				Unit		Units and expressions not recommended
French name	English name	Symbol	Definition	SI	Non SI, but accepted	Conversion
Niveau de puissance acoustique	Sound power level	L_w	$L_w = 10 \lg(P/P_o)$ ($P_o = 10^{-12} W$)	dB (decibel)		lg logarithm to base 10 lg10 = 1
Niveau de pression acoustique	Sound pressure level	L_p	$L_p = 20 \lg(P/P_o)$ ($P_o = 2 \times 10^{-5} Pa$)	dB		

DIMENSIONS

Parameters				Unit		Units and expressions not recommended
French name	English name	Symbol	Definition	SI	Non SI, but accepted	Conversion
Angle (angle plan)	Angle (plane angle)	$\alpha, \beta, T, \varphi$		rad	degree: ° minute: ' second: "	180° = π rad = 3.14 rad
Longueur Largeur Hauteur Rayon Longueur curviligne	Length Breadth Height Radius	l b h r s		m (meters)	micrometer	cm, dm, dam, hm 1 inch = 1" = 25.4 mm 1 foot = 1' = 304.8 mm μ m micron μ angstrom: A = 0.10 nm
Aire, superficie	Area	A, S		m ²		1 square inch = $6.45 \cdot 10^{-4} m^2$
Volume	Volume	V		m ³	litre: l liter: L	UK gallon = $4.546 \cdot 10^{-3} m^3$ US gallon = $3.785 \cdot 10^{-3} m^3$

Appendix Units of Measurement and Standard Formulae

MECHANICS

Parameters				Unit		Units and expressions not recommended
French name	English name	Symbol	Definition	SI	Non SI, but accepted	Conversion
Temps Intervalle de temps, durée Période (durée d'un cycle)	Time	t		s (second)	minute: min hour: h day: d	Symbols ' and " are reserved for angles minute not written as mn
	Period (periodic time)	T				
Vitesse angulaire Pulsation	Angular velocity	ω	$\omega = \frac{d\phi}{dt}$	rad/s		
	Circular frequency					
Accélération angulaire	Angular acceleration	α	$\alpha = \frac{d\omega}{dt}$	rad/s ²		
Vitesse	Speed	$u, v, w,$	$v = \frac{ds}{dt}$	m/s	1 km/h = 0.277,778 m/s 1 m/min = 0.0166 m/s	
Célérité	Velocity	c				
Accélération	Acceleration	a	$a = \frac{dv}{dt}$	m/s ²		
Accélération de la pesanteur	Acceleration of free fall	$g=9.81m/s^2$	<i>in Paris</i>			
Vitesse de rotation	Revolution per minute	N		s ⁻¹	min ⁻¹	tr/mn, RPM, TM, etc.
Masse	Mass	m		kg (kilogram)	tonne: t 1 t = 1000 kg	kilo, kgs, KG, etc. 1 pound: 1 lb = 0.4536 kg
Masse volumique	Mass density	ρ	$\frac{dm}{dV}$	kg/m ³		
Masse linéique	Linear density	ρ_e	$\frac{dm}{dL}$	kg/m		
Masse surfacique	Surface mass	ρ_A	$\frac{dm}{dS}$	kg/m ²		
Quantité de mouvement	Momentum	P	$p = m.v$	kg. m/s		
Moment d'inertie	Moment of inertia	J, I	$I = \sum m.r^2$	kg.m ²		$J = \frac{MD^2}{4}$ kg.m ² pound per square foot = 1 lb.ft ² = 42.1 x 10 ⁻³ kg.m ²
Force Poids	Force Weight	F G	$G = m.g$	N (newton)		kgf = kgp = 9.81 N pound force = lbf = 4.448 N
Moment d'une force	Moment of force, Torque	M T	$M = F.r$	N.m		mdaN, mkg, m.N 1 mkg = 9.81 N.m 1 ft.lbf = 1.356 N.m 1 in.lbf = 0.113 N.m
Pression	Pressure	p	$p = \frac{F}{S} = \frac{F}{A}$	Pa (pascal)	bar 1 bar = 10 ⁵ Pa	1 kgf/cm ² = 0.981 bar 1 psi = 6894 N/m ² = 6894 Pa 1 psi = 0.06894 bar 1 atm = 1.013 x 10 ⁵ Pa
Contrainte normale Contrainte tangentielle, Cission	Normal stress Shear stress	σ τ		Pa Leroy-Somer use the MPa = 10 ⁶ Pa		kg/mm ² , 1 daN/mm ² = 10 MPa psi = pound per square inch 1 psi = 6894 Pa
Facteur de frottement	Friction coefficient	μ				incorrectly = friction coefficient f
Travail Énergie Énergie potentielle Énergie cinétique Quantité de chaleur	Work Energy Potential energy Kinetic energy Quantity of heat	W E Ep Ek Q	$W = F.l$	J (joule)	Wh = 3600 J (watt-hour)	1 N.m = 1 W.s = 1 J 1 kgm = 9.81 J (calorie) 1 cal = 4.18 J 1 Btu = 1055 J (British thermal unit)
Puissance	Power	P	$P = \frac{W}{t}$			W (watt)
Débit volumique	Volumetric flow	q_v	$q_v = \frac{dV}{dt}$	m ³ /s		
Rendement	Efficiency	η		< 1		%
Viscosité dynamique	Dynamic viscosity	η, μ		Pa.s		poise, 1 P = 0.1 Pa.s
Viscosité cinématique	Kinematic viscosity	ν	$\nu = \frac{\eta}{\rho}$	m ² /s		stokes, 1 St = 10 ⁻⁴ m ² /s

Appendix Unit Conversions

Unit	MKSA (IS international system)	AGMA (US system)
Length	1 m = 3.2808 ft 1 mm = 0.03937 in	1 ft = 0.3048 m in = 25.4 mm
Weight	1 kg = 2.2046 lb	1 lb = 0.4536 kg
Torque	1 Nm = 0.7376 lb.ft 1 N.m = 141.6 oz.in	1 lb.ft = 1.356 N.m 1 oz.in = 0.00706 N.m
Force	1 N = 0.224 8 lb	1 lb = 4.448 N
Moment of inertia	1 kg.m ² = 23.73 lb.ft ²	1 lb.ft ² = 0.04214 kg.m ²
Power	1 kW = 1.341 HP	1 HP = 0.746 kW
Pressure	1 kPa = 0.14505 psi	1 psi = 6.894 kPa
Magnetic flux	1 T = 1 Wb/m ² = 6.452 10 ⁴ line/in ²	1 line/in ² = 1.550 10 ⁻⁶ Wb/m ²
Magnetic losses	1 W/kg = 0.4536 W/lb	1 W/lb = 2.204 W/kg

Multiples and sub-multiples		
Factor by which the unit is multiplied	Prefix to be placed before the unit name	Symbol to be placed before that of the unit
10 ¹⁸ or 1,000,000,000,000,000,000	exa	E
10 ¹⁵ or 1,000,000,000,000,000	peta	P
10 ¹² or 1,000,000,000,000	tera	T
10 ⁹ or 1,000,000,000	giga	G
10 ⁶ or 1,000,000	mega	M
10 ³ or 1000	kilo	k
10 ² or 100	hecto	h
10 ¹ or 10	deca	da
10 ⁻¹ or 0.1	deci	d
10 ⁻² or 0.01	centi	c
10 ⁻³ or 0.001	milli	m
10 ⁻⁶ or 0.000,001	micro	μ
10 ⁻⁹ or 0.000,000,001	nano	n
10 ⁻¹² or 0.000,000,000,001	pico	p
10 ⁻¹⁵ or 0.000,000,000,000,001	femto	f
10 ⁻¹⁸ or 0.000,000,000,000,000,001	atto	a

Appendix Standard Formulae Used in Electrical Engineering

MECHANICAL FORMULAE

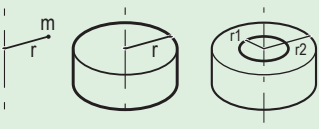
Title	Formula	Unit	Definitions/Notes
Force	$F = m \cdot \gamma$	F in N m in kg γ in m/s ²	A force F is the product of a mass m by an acceleration γ
Weight	$G = m \cdot g$	G in N m in kg $g = 9.81$ m/s ²	
Moment	$M = F \cdot r$	M in N.m F in N r in m	The moment M of a force in relation to an axis is the product of that force multiplied by the distance r of the point of application of F in relation to the axis.
Power	- Rotation $P = M \cdot \omega$	P in W M in N.m ω in rad/s	Power P is the quantity of work yielded per unit of time $\omega = 2\pi N/60$ where N is the speed of rotation in rpm
	- Linear $P = F \cdot V$	P in W F in N V in m/s	$V =$ linear velocity
Acceleration time	$t = J \cdot \frac{\omega}{M_a}$	t in s J in kg.m ² ω in rad/s M_a in Nm	J is the moment of inertia of the system M_a is the moment of acceleration Note: All the calculations refer to a single rotational speed ω , where the inertias at speed ω' are corrected to speed ω by the following calculation: $J_\omega = J_{\omega'} \cdot \left(\frac{\omega'}{\omega}\right)^2$
Moment of inertia Center of gravity	$J = m \cdot r^2$		
Solid cylinder around its axis	$J = m \cdot \frac{r^2}{2}$	J in kg.m ² m in kg r in m	
Hollow cylinder around its axis	$J = m \cdot \frac{r_1^2 + r_2^2}{2}$		
Inertia of a mass in linearmotion	$J = m \cdot \left(\frac{v}{\omega}\right)^2$	J in kg.m ² m in kg v in m/s ω in rad/s	The moment of inertia of a mass in linear motion transformed to a rotating motion.

Appendix Standard Formulae Used in Electrical Engineering

ELECTRICAL FORMULAE

Title	Formula	Unit	Definitions/Notes
Accelerating torque	$M_a = \frac{M_D + 2M_A + 2M_M + M_N}{6} - M_r$ <p>General formula:</p> $M_a = \frac{1}{N_N} \int_0^{N_N} (M_{mot} - M_r) dN$	Nm	Moment of acceleration M_a is the difference between the motor torque M_{mot} (estimated), and the resistive torque M_r . (M_D , M_A , M_M , M_N , see curve below) N = instantaneous speed N_N = rated speed
Power required by the machine	$P = \frac{M \cdot \omega}{\eta_A}$	P in W M in N.m ω in rad/s η_A no units	η_A expresses the efficiency of the driven machine. M is the torque required by the driven machine.
Power drawn by the 3-phase motor	$P = \sqrt{3} \cdot U \cdot I \cdot \cos \varphi$	P in W U in V I in A	φ phase angle by which the current lags or leads the voltage U armature voltage I line current
Reactive power drawn by the motor	$Q = \sqrt{3} \cdot U \cdot I \cdot \sin \varphi$	Q in VAR	
Reactive power supplied by a bank of capacitors	$Q = \sqrt{3} \cdot U^2 \cdot C \cdot \omega$	U in V C in μ F ω in rad/s	U = voltage at the capacitor terminals C = capacitor capacitance ω = rotational frequency of supply phases ($\omega = 2\pi f$)
Apparent power	$S = \sqrt{3} \cdot U \cdot I$ $S = \sqrt{P^2 + Q^2}$	S in VA	
Power supplied by the 3-phase motor	$P = \sqrt{3} \cdot U \cdot I \cdot \cos \varphi \cdot \eta$		η expresses motor efficiency at the point of operation under consideration.
Slip	$g = \frac{N_S - N}{N_S}$		Slip is the difference between the actual motor speed N and the synchronous speed N_S
Synchronous speed	$N_S = \frac{120 \cdot f}{p}$	N_S in min^{-1} f in Hz	p = number of poles f = frequency of the A.C. supply

Parameters	Symbols	Unit	Torque and current curve according to speed
Starting current Rated current No-load current	I_D I_N I_O	A	
Starting torque* Run-up torque	M_D M_A	Nm	
Maximum torque breakdown	M_M		
Rated torque	M_N		
Rated speed Synchronous speed	N_N N_S	rpm	

* Torque is the usual term for expressing the moment of a force.

Appendix Tolerance on Main Performance Parameters

TOLERANCES ON ELECTROMECHANICAL CHARACTERISTICS

IEC 60034-1 specifies standard tolerances for electromechanical characteristics.

Parameters	Tolerances
Efficiency $\left\{ \begin{array}{l} \text{machines } P \leq 150 \text{ kW} \\ \text{machines } P > 150 \text{ kW} \end{array} \right.$	$- 15\% \text{ of } (1 - \eta)$ $- 10\% \text{ of } (1 - \eta)$
Cos ϕ	$- 1/6 (1 - \cos \phi)$ (min 0.02 - max 0.07)
Slip $\left\{ \begin{array}{l} \text{machines } P < 1 \text{ kW} \\ \text{machines } P \geq 1 \text{ kW} \end{array} \right.$	$\pm 30\%$ $\pm 20\%$
Locked rotor torque	$- 15\%, + 25\% \text{ of rated torque}$
Starting current	$+ 20\%$
Run-up torque	$- 15\% \text{ of rated torque}$
Breakdown torque	$- 10\% \text{ of rated torque}$ $> 1.5 M_N$
Moment of inertia	$\pm 10\%$
Noise	$+ 3 \text{ dB (A)}$
Vibrations	$+ 10\% \text{ of the guaranteed class}$

Note: IEC 60034-1 does not specify tolerances for current
- the tolerance is $\pm 10\%$ in NEMA-MG1

TOLERANCES AND ADJUSTMENTS

The standard tolerances shown below are applicable to the drawing dimensions given in our catalogs. They comply fully with the requirements of IEC standard 60072-1.

Characteristic	Tolerances
Frame size $H \leq 250$ ≥ 280	$0, - 0.5 \text{ mm}$ $0, - 1 \text{ mm}$
Diameter \varnothing of the shaft extension: - 11 to 28 mm - 32 to 48 mm - 55 mm and over	j6 k6 m6
Diameter N of flange spigots	j6 up to FF 500, js6 for FF 600 and over
Key width	h9
Width of drive shaft keyway (normal keying)	N9
Key depth: - square section - rectangular section	h9 h11
① Eccentricity of shaft in flanged motors (standard class) - diameter > 10 up to 18 mm - diameter > 18 up to 30 mm - diameter > 30 up to 50 mm - diameter > 50 up to 80 mm - diameter > 80 up to 120 mm	0.035 mm 0.040 mm 0.050 mm 0.060 mm 0.070 mm
② Concentricity of spigot diameter and ③ Perpendicularity of mating surface of flange in relation to shaft (standard class) Flange (FF) or Faceplate (FT): - F 55 to F 115 - F 130 to F 265 - FF 300 to FF 500 - FF 600 to FF 740 - FF 940 to FF 1080	0.08 mm 0.10 mm 0.125 mm 0.16 mm 0.20 mm

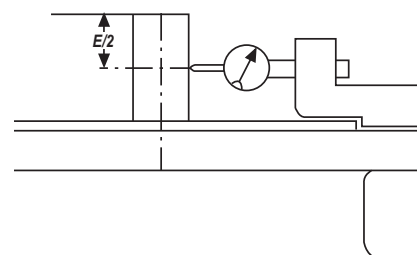

① **Eccentricity of shaft in flanged motors**

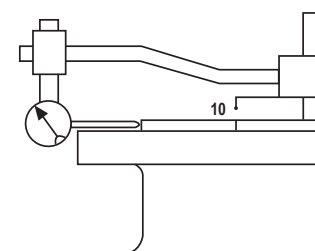

② **Concentricity of spigot diameter**

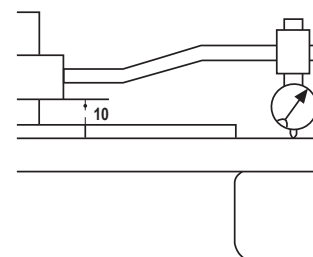

③ **Perpendicularity of mating surface of flange in relation to shaft**

Appendix Configurator



The Leroy-Somer configurator can be used to choose the most suitable motor and provides the technical specifications and corresponding drawings.

To register online:

<http://www.emersonindustrial.com/fr-FR/leroy-somer-motors-drives/Products/Configurator/>

- Help with product selection
- Print-outs of technical specifications
- Print-outs of 2D and 3D CAD files
- The equivalent of 400 catalogs in 16 languages

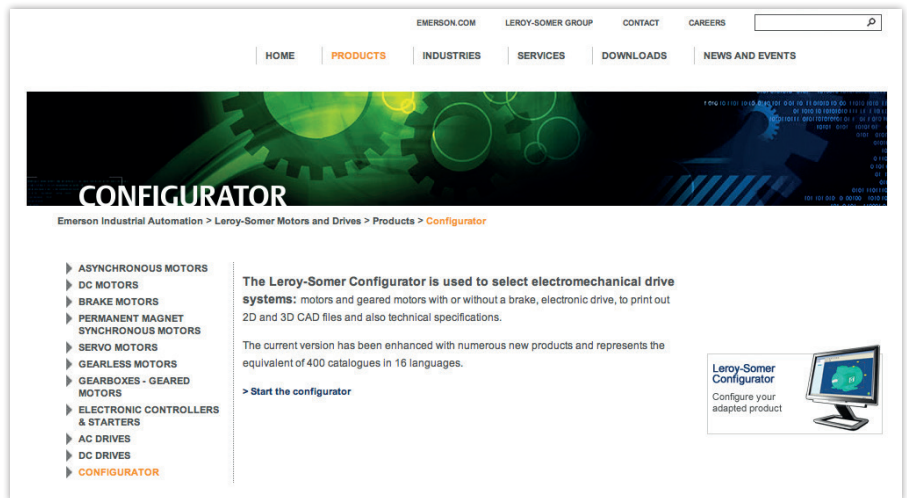

The screenshot shows the website's navigation menu with options: HOME, PRODUCTS, INDUSTRIES, SERVICES, DOWNLOADS, NEWS AND EVENTS. The main banner features the word "CONFIGURATOR" in large white letters over a green gear background. Below the banner, a breadcrumb trail reads: Emerson Industrial Automation > Leroy-Somer Motors and Drives > Products > Configurator. A left sidebar lists product categories with arrows: ASYNCHRONOUS MOTORS, DC MOTORS, BRAKE MOTORS, PERMANENT MAGNET SYNCHRONOUS MOTORS, SERVO MOTORS, GEARLESS MOTORS, GEARBOXES - GEARED MOTORS, ELECTRONIC CONTROLLERS & STARTERS, AC DRIVES, DC DRIVES, and CONFIGURATOR (highlighted in orange). The main content area contains the text: "The Leroy-Somer Configurator is used to select electromechanical drive systems: motors and geared motors with or without a brake, electronic drive, to print out 2D and 3D CAD files and also technical specifications." It also states: "The current version has been enhanced with numerous new products and represents the equivalent of 400 catalogues in 16 languages." and includes a link: "> Start the configurator". A small inset image shows a computer monitor with the configurator interface, labeled "Leroy-Somer Configurator" and "Configure your adapted product".

LEROY-SOMER[™]

www.leroy-somer.com

Connect with us at:

twitter.com/Leroy_Somer_en

facebook.com/leroy-somer.nidec.en

youtube.com/user/LeroySomerOfficiel

linkedin.com/company/leroy-somer



Nidec
All for dreams

© 2019 Moteurs Leroy-Somer SAS. The information contained in this brochure is for guidance only and does not form part of any contract. The accuracy cannot be guaranteed as Moteurs Leroy-Somer SAS have an ongoing process of development and reserve the right to change the specification of their products without notice.

Moteurs Leroy-Somer SAS. Headquarters: Bd Marcellin Leroy, CS 10015, 16915 Angoulême Cedex 9, France. Share Capital: 65 800 512 €, RCS Angoulême 338 567 258.